

TABLE OF CONTENTS

Bollards

<u>PAGE</u>	<u>STYLE</u>	<u>CATALOG NUMBER</u>
BD 1	Washington Bollards	BDWSH-12-3.50/3.32
BD 2	Washington-M3 Bollards	BDWSH-M3-13.65/3.47
BD 3	Washington Tampa Bollards	BDWST-13-3.69
BD 4	Madison Bollards	BDMDS-18.5-3.58/2.67
BD 5	Madison Bollards	BDMDS-18-3.58
BD 6	Edgewater Bollards	BDEDG-16-4.42/3.50
BD 7	Hancock Bollards	BDHNC-16-3.46/3.67
BD 8	Hancock Bollards	BDHNC-15-4.21/11-4.42
BD 9	Pacific Bollards	BDPAC-12-3.67/3.06
BD 10	Mount View Bollards	BDMNV-12-3.58
BD 11	Mini Mariner Bollards	BDMNM-12-3.58
BD 12	Station Light Bollards	BDSTT-11-3.40
BD 13	Newburyport Bollards	BDNBP-13-3.25
BD 14	Wayzata Bollards	BDWZT-10-4.58/3.86
BD 15	Princeton Bollards	BDPRC-12-4.17/3.58/10-3.58
BD 16	OSU Bollard	BDOSU-18-3.50
BD 17	Northampton Bollard	BDNRT-20-3.81/12-3.04
BD 18	Radnor Bollard	BDRDN-10-4.30/3.88
BD 19	Wellington Bollards	BDWLG-10-2.698/2.55
BD 20	Barcelona Bollards	BDBRC-10-3.38/2.88
BD 21	Reston Bollard	BDRST-12-3.08
BD 22	Twin Lakes Bollards	BDTWL-10-2.00/3.00

BD 23 Kimball Street BollardsBDKMB-09-1.75

BD 24 Yorktown Bollard.....BDYRK-12-4.19

BD 25 Madrid BollardBDMDR-12-2.75/2.57

Washington Bollards

Catalog No.: BDWSH-12-3.50/3.32

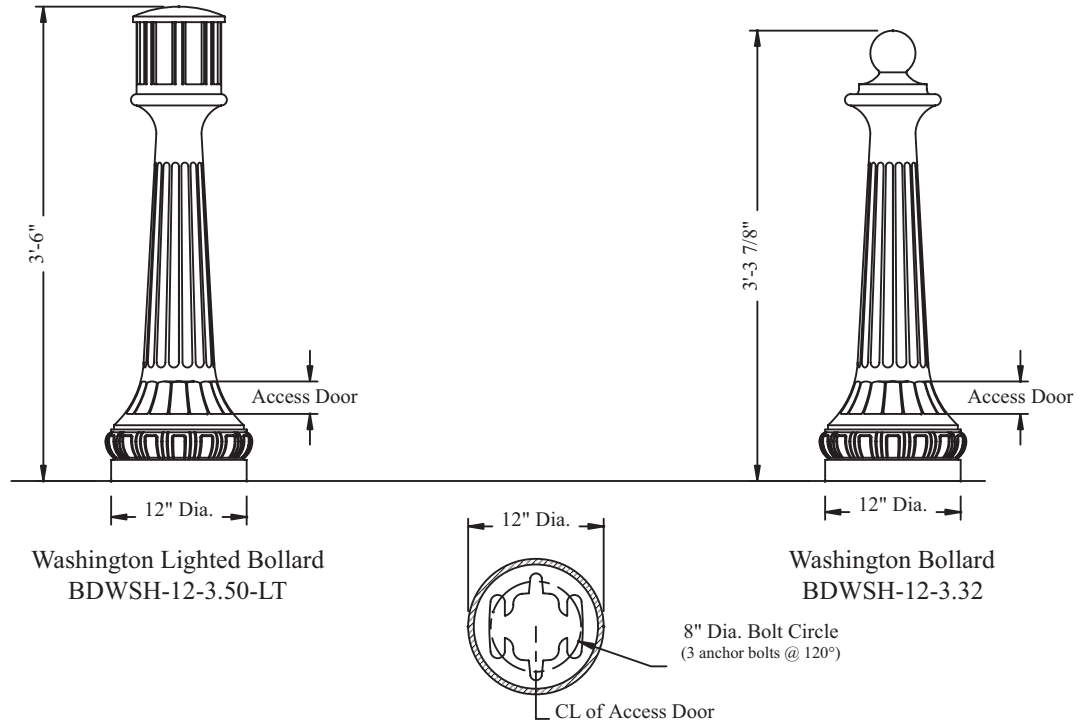

Lighted Bollard Catalog Number Example: DBDWSH-12-3.50-LT-MH050-PV1-SD-YCLO-L55-323/1NW-CB
 (Cast Ductile Iron Bollard Washington-12" Base Dimension-3'6" Height-Lighted-50 Watt Metal Halide-Postline Ballast 120 Volt-Medium Base Socket- Acrylic Clear Cylinder-Internal Type V Refractor-3/4" x 24" Anchor Bolts each with 1 Nut & Washer- Finish Classic Black)

Material Product Style - Base Dimension - Height (see above)-

- ___ IBDWSH-12-___(Ht)- Cast Iron Bollard Washington -12" - ___Ht-
- ___ DBDWSH-12-___(Ht)- Cast Ductile Iron Bollard Washington -12" - ___Ht-
- ___ ABDWSH-12-___(Ht)- Cast Aluminum Bollard Washington -12" - ___Ht-

Modifications

- ___ DD- Direct Burial
- ___ RM- Removable
- ___ DP- Dedication Plaque
- ___ LT- Lighted
- ___ EB- Eyebolt

Lamping

- ___ IN- Incandescent
- ___ MH050- 50 Watt Metal Halide (120 V only)
- ___ HP050- 50 Watt High pressure sodium (120 V only)
- ___ HP070- 70 Watt High pressure sodium (120, 208, 240 or 277 V)
- ___ HP100- 100 Watt High pressure sodium (120, 208, 240 or 277 V)
- ___ CF028- 28 Watt Compact Fluorescent (120, 208, 240 or 277 V)
- ___ CF032- 32 Watt Compact Fluorescent (120, 208, 240 or 277 V)
- ___ CF042- 42 Watt Compact Fluorescent (120, 208, 240 or 277 V)

Ballast Type

- ___ P Postline

Voltage

- ___ V1 120 Volt
- ___ V8 208 Volt
- ___ V2 240 Volt
- ___ V7 277 Volt

Socket

- ___ SD Medium Base
- ___ SF Fluorescent

Cylinder

- ___ YCLO Clear Acrylic
- ___ YCLF Frosted Acrylic

Internal Refractor

- ___ L55 Internal Type V

Anchor Bolts:

- ___ 323/ 3/4" x 24"
- ___ 330/ 3/4" x 30"
- ___ 124/ 1" x 24"
- ___ 1NW- 1Nut & Washer / Bolt
- ___ 2NW- 2 Nuts & Washers / Bolt
- ___ 130/ 1" x 30"
- ___ 136/ 1" x 36"
- ___ 140/ 1" x 40"

Paint

- ___ PO Prime Only
- ___ BG Bottle Green
- ___ GI Grey Iron
- ___ LB Long Beach Blue
- ___ CW Custom Wet
- ___ CP Custom Powder
- ___ CB Classic Black
- ___ VG Verde Green
- ___ DB Dark Bronze
- ___ UF Unfinished
- ___ XX Modifier



SPRING CITY ELECTRICAL MFG. CO., INC.

Hall & Main Streets, P. O. Box 19
 Spring City, PA 19475-0019
 Phone: 610-948-4000 Fax: 610-948-5577
 Website: www.springcity.com

Washington-M3 Bollards

Catalog No.: BDWSH-13-3.65/3.47-M3

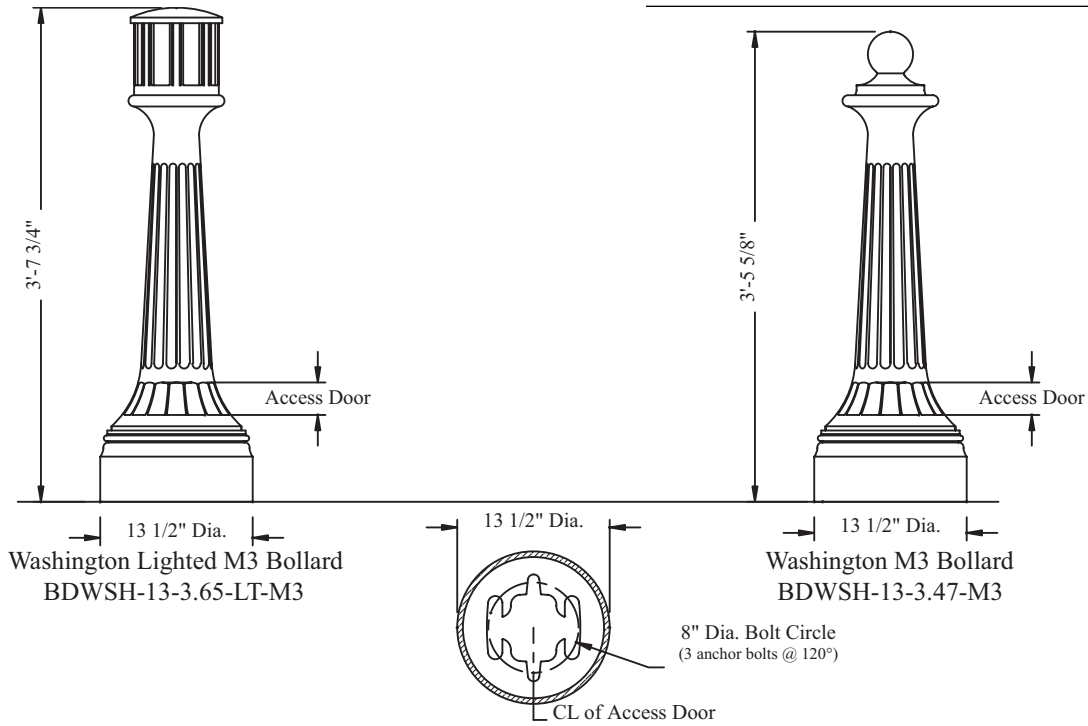

Lighted Bollard Catalog Number Example: DBDWS-13-3.65-LT-MH050-PV1-SD-YCLO-L55-323/1NW-CB
 (Cast Ductile Iron Bollard Washington-M3-13 1/2" Base Dimension-3' 7 3/4" Height-Lighted-50 Watt Metal Halide-Postline Ballast 120 Volt-Medium Base Socket- Acrylic Clear Cylinder-Internal Type V Refractor-3/4" x 24" Anchor Bolts each with 1 Nut & Washer- Finish Classic Black)

Material Product Style - Base Dimension - Height (see above)-
 ___ IBDWSH-13-___(Ht)- Cast Iron Bollard Washington -13 1/2"-___Ht-
 ___ DBDWSH-13-___(Ht)- Cast Ductile Iron Bollard Washington -
 13 1/2"- ___Ht-
 ___ ABDWSH-13-___(Ht)- Cast Aluminum Bollard Washington -13 1/2" -
 ___Ht-

Modifications

___ DD- Direct Burial ___ LT- Lighted
 ___ RM- Removable ___ EB- Eyeball
 ___ DP- Dedication Plaque

Lamping

___ IN- Incandescent
 ___ MH050- 50 Watt Metal Halide (120 V only)
 ___ HP050- 50 Watt High pressure sodium (120 V only)
 ___ HP070- 70 Watt High pressure sodium (120, 208, 240 or 277 V)
 ___ HP100- 100 Watt High pressure sodium (120, 208, 240 or 277 V)
 ___ CF028- 28 Watt Compact Fluorescent (120, 208, 240 or 277 V)
 ___ CF032- 32 Watt Compact Fluorescent (120, 208, 240 or 277 V)
 ___ CF042- 42 Watt Compact Fluorescent (120, 208, 240 or 277 V)

Ballast Type

___ P Postline

Voltage

___ V1 120 Volt ___ V2 240 Volt
 ___ V8 208 Volt ___ V7 277 Volt

Socket

___ SD Medium Base ___ SF Fluorescent

Cylinder

___ YCLO Clear Acrylic ___ YCLF Frosted Acrylic

Internal Refractor

___ L55 Internal Type V

Anchor Bolts:

___ 323/ 3/4" x 24" ___ 130/ 1" x 30"
 ___ 330/ 3/4" x 30" ___ 136/ 1" x 36"
 ___ 124/ 1" x 24" ___ 140/ 1" x 40"
 ___ 1NW- 1Nut & Washer / Bolt
 ___ 2NW- 2 Nuts & Washers / Bolt

Paint

___ PO Prime Only ___ CB Classic Black
 ___ BG Bottle Green ___ VG Verde Green
 ___ GI Grey Iron ___ DB Dark Bronze
 ___ LB Long Beach Blue ___ UF Unfinished
 ___ CW Custom Wet ___ XX Modifier
 ___ CP Custom Powder, advise _____



SPRING CITY ELECTRICAL MFG. CO., INC.

Hall & Main Streets, P. O. Box 19

Spring City, PA 19475-0019

Phone: 610-948-4000 Fax: 610-948-5577

Website: www.springcity.com

Revision 10/2008

Page: BD 2

Washington Tampa Bollards

Catalog No.: BDWST-13-3.69

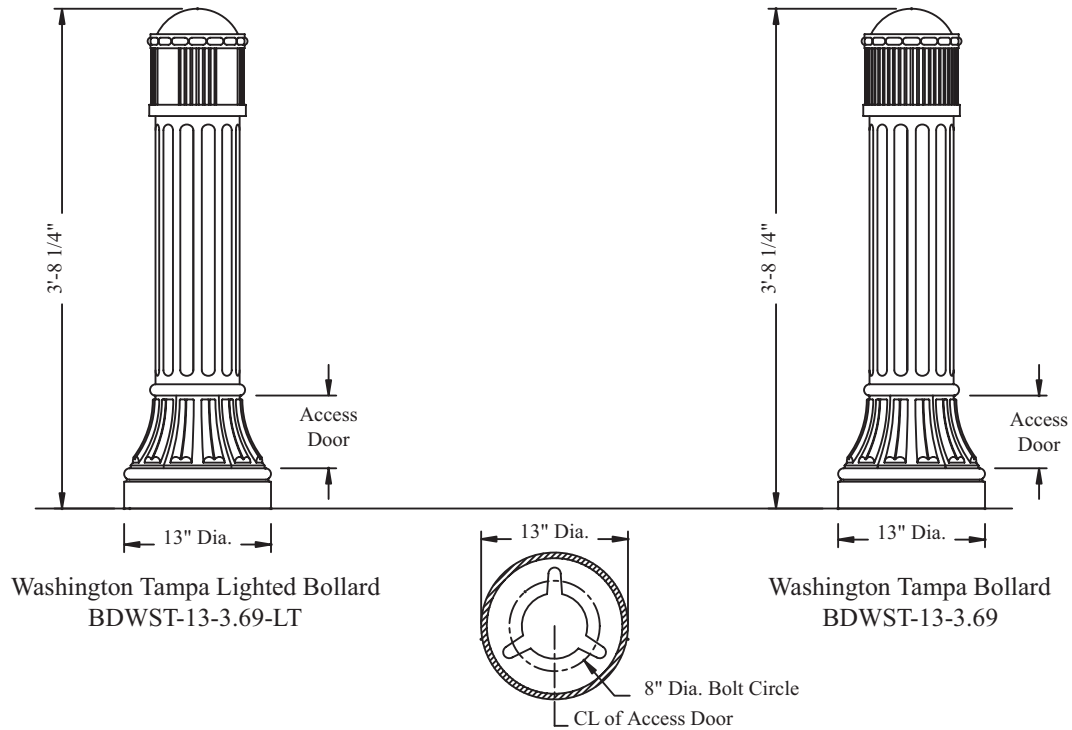

Lighted Bollard Catalog Number Example: DBDWST-13-3.69-LT-MH050-PV1-SD-YCLO-L55-323/1NW-CB
 (Cast Ductile Iron Bollard Washington Tampa-13" Base Dimension-3' 8 1/4" Height-Lighted-50 Watt Metal Halide-Postline Ballast 120 Volt-Medium Base Socket- Acrylic Clear Cylinder-Internal Type V Refractor-3/4" x 24" Anchor Bolts each with 1 Nut & Washer- Finish Classic Black)

Material Product Style - Base Dimension - Height-

- ___ IBDWST-13-3.69- Cast Iron Bollard Washington Tampa-13"-3' 8 1/4"
- ___ DBDWST-13-3.69- Cast Ductile Iron Bollard Washington Tampa-13"-3' 8 1/4"
- ___ ABDWST-13-3.69- Cast Aluminum Bollard Washington Tampa-13"-3' 8 1/4"

Modifications

- ___ DD- Direct Burial ___ LT- Lighted
- ___ RM- Removable ___ EB- Eyebolt
- ___ DP- Dedication Plaque

Lamping

- ___ IN- Incandescent
- ___ MH035- 35 Watt Metal Halide (120 or 277 V) F-can Ballast Only
- ___ MH050- 50 Watt Metal Halide (120 V only)
- ___ MH070- 70 Watt Metal Halide (120 or 277 V) F-can Ballast Only
- ___ MH100- 100 Watt Metal Halide (120 or 277 V) F-can Ballast Only
- ___ HP035- 35 Watt High pressure sodium (120 V only)
- ___ HP050- 50 Watt High pressure sodium (120 V only)
- ___ HP070- 70 Watt High pressure sodium (120, 208, 240 or 277 V)
- ___ HP100- 100 Watt High pressure sodium (120, 208, 240 or 277 V)
- ___ CF028- 28 Watt Compact Fluorescent (120, 208, 240 or 277 V)
- ___ CF032- 32 Watt Compact Fluorescent (120, 208, 240 or 277 V)
- ___ CF042- 42 Watt Compact Fluorescent (120, 208, 240 or 277 V)

Ballast Type

- ___ P Postline ___ F F-can (120/277 Volts Only)

Voltage

- ___ V1 120 Volt ___ V2 240 Volt
- ___ V8 208 Volt ___ V7 277 Volt

Socket

- ___ SD Medium Base ___ SF Fluorescent

Cylinder

- ___ YCLO Clear Acrylic ___ YCLF Frosted Acrylic

Internal Refractor

- ___ L55 Internal Type V

Anchor Bolts:

- ___ 323/ 3/4" x 24" ___ 130/ 1" x 30"
- ___ 330/ 3/4" x 30" ___ 136/ 1" x 36"
- ___ 124/ 1" x 24" ___ 140/ 1" x 40"
- ___ 1NW- 1Nut & Washer / Bolt
- ___ 2NW- 2 Nuts & Washers / Bolt

Paint

- ___ PO Prime Only ___ CB Classic Black
- ___ BG Bottle Green ___ VG Verde Green
- ___ GI Grey Iron ___ DB Dark Bronze
- ___ LB Long Beach Blue ___ UF Unfinished
- ___ CW Custom Wet ___ XX Modifier
- ___ CP Custom Powder



SPRING CITY ELECTRICAL MFG. CO., INC.

Hall & Main Streets, P. O. Box 19
 Spring City, PA 19475-0019
 Phone: 610-948-4000 Fax: 610-948-5577
 Website: www.springcity.com

Madison Bollards

Catalog No.: BDMDS-18-3.58/2.67

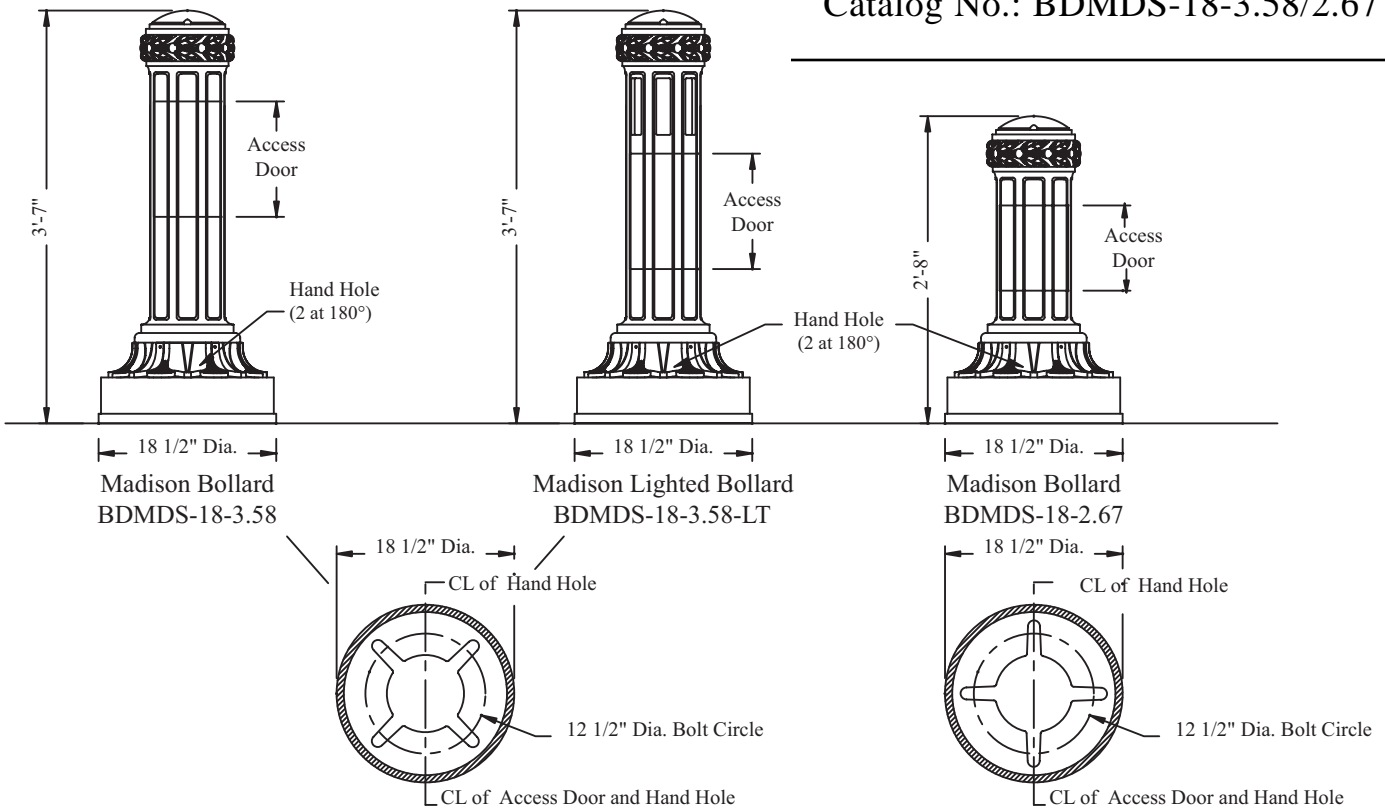

Lighted Bollard Catalog Number Example: DBDMDS-18-3.58-LT-MH050-PV1-SD-YCLO-L55-323/1NW-CB
 (Cast Ductile Iron Bollard Madison-18 1/2" Base Dimension-3' 7" Height-Lighted-50 Watt Metal Halide-Postline Ballast 120 Volt-Medium Base Socket- Acrylic Clear Cylinder-Internal Type V Refractor-3/4" x 24" Anchor Bolts each with 1 Nut & Washer- Finish Classic Black)

Material Product Style - Base Dimension - Height (see above)-

- ___ IBDMDS-18-__(Ht)- Cast Iron Bollard Madison - 18 1/2" - __ Ht.
- ___ DBDMDS-18-__(Ht)- Cast Ductile Iron Bollard Madison - 18 1/2" - __ Ht.
- ___ ABDMDS-18-__(Ht.)- Cast Aluminum Bollard Madison - 18 1/2" - __ Ht.

Modifications

- ___ DD- Direct Burial ___ LT- Lighted
- ___ RM- Removable ___ EB- Eyebolt
- ___ DP- Dedication Plaque

Lamping

- ___ IN- Incandescent
- ___ MH035- 35 Watt Metal Halide (120 or 277 V) F-can Ballast Only
- ___ MH050- 50 Watt Metal Halide (120 V only)
- ___ MH070 - 70 Watt Metal Halide (120 or 277 V) F- can Ballast Only
- ___ MH100- 100 Watt Metal Halide (120 or 277 V) F-can Ballast Only
- ___ HP035- 35 Watt High pressure sodium (120 V only)
- ___ HP050- 50 Watt High pressure sodium (120 V only)
- ___ HP070- 70 Watt High pressure sodium (120, 208, 240 or 277 V)
- ___ HP100- 100 Watt High pressure sodium (120, 208, 240 or 277 V)
- ___ CF028- 28 Watt Compact Fluorescent (120, 208, 240 or 277 V)
- ___ CF032- 32 Watt Compact Fluorescent (120, 208, 240 or 277 V)
- ___ CF042- 42 Watt Compact Fluorescent (120, 208, 240 or 277 V)

Ballast Type

- ___ P Postline ___ F F-can (120/277 Volts Only)

Voltage

- ___ V1 120 Volt ___ V2 240 Volt
- ___ V8 208 Volt ___ V7 277 Volt

Socket

- ___ SD Medium Base ___ SF Fluorescent

Cylinder

- ___ YCLO Clear Acrylic ___ YCLF Frosted Acrylic

Internal Refractor

- ___ L55 Internal Type V

Anchor Bolts:

- ___ 323/ 3/4" x 24" ___ 130/ 1" x 30"
- ___ 330/ 3/4" x 30" ___ 136/ 1" x 36"
- ___ 124/ 1" x 24" ___ 140/ 1" x 40"
- ___ 1NW- 1Nut & Washer / Bolt
- ___ 2NW- 2 Nuts & Washers / Bolt

Paint

- ___ PO Prime Only ___ CB Classic Black
- ___ BG Bottle Green ___ VG Verde Green
- ___ GI Grey Iron ___ DB Dark Bronze
- ___ LB Long Beach Blue ___ UF Unfinished
- ___ CW Custom Wet ___ XX Modifier
- ___ CP Custom Powder, advise



SPRING CITY ELECTRICAL MFG. CO., INC.

Hall & Main Streets, P. O. Box 19
 Spring City, PA 19475-0019
 Phone: 610-948-4000 Fax: 610-948-5577
 Website: www.springcity.com

Revision 10/2008

Page: BD 4

Madison Bollards

Catalog No.: BDMDS-18-3.58

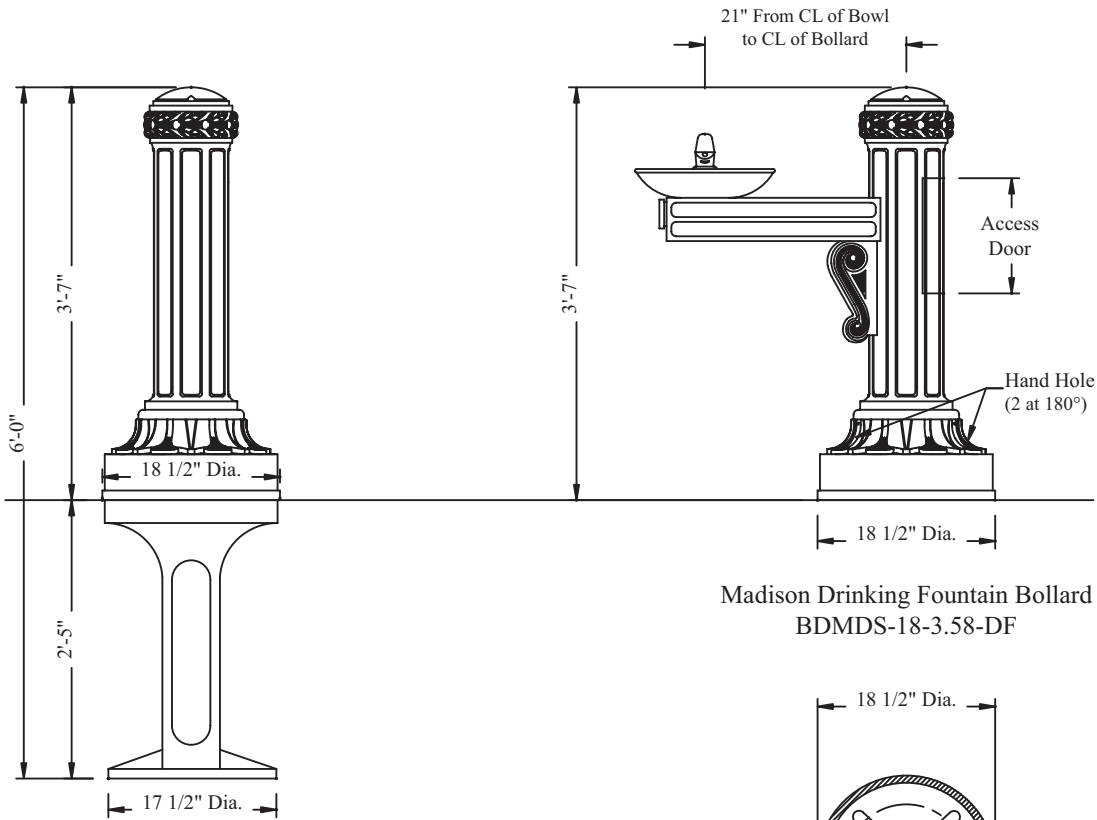

Madison Direct Burial Bollard
BDMDS-18-3.58-DD

Madison Drinking Fountain Bollard
BDMDS-18-3.58-DF

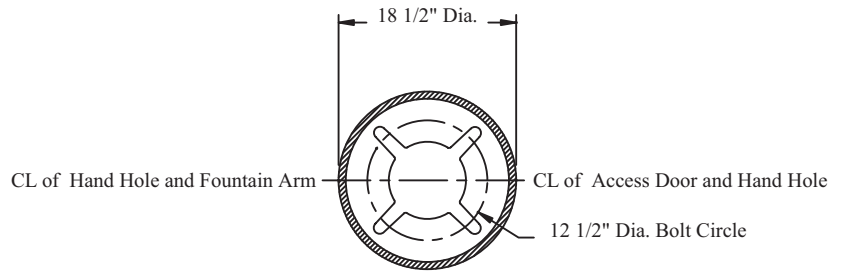

Catalog Number Example: DBDMDS-18-3.58-DF-323/1NW-CB

(Cast Ductile Iron Bollard Madison-18 1/2" Base Dimension-3' 7" Height-Drinking Fountain-3/4" x 24" Anchor Bolts each with 1 Nut & Washer-Finish Classic Black)

Material Product Style - Base Dimension - Height -

- ___ IBDMS-18-3.58 Cast Iron Bollard Madison - 18 1/2" - 3' 7"
- ___ DBDMDS-18-3.58 Cast Ductile Iron Bollard Madison - 18 1/2" - 3' 7"
- ___ ABDMDS-18-3.6 Cast Aluminum Bollard Madison - 18 1/2" - 3' 7"

Modifications

- ___ DD- Direct Burial
- ___ DF- Drinking Fountain
- ___ EB- Eyebolt
- ___ DP- Dedication Plaque

Anchor Bolts:

- ___ 323/ 3/4" x 24" ___ 130/ 1" x 30"
- ___ 330/ 3/4" x 30" ___ 136/ 1" x 36"
- ___ 124/ 1" x 24" ___ 140/ 1" x 40"
- ___ 1NW- 1Nut & Washer / Bolt
- ___ 2NW- 2 Nuts & Washers / Bolt

Paint

- ___ PO Prime Only ___ CB Classic Black
- ___ BG Bottle Green ___ VG Verde Green
- ___ GI Grey Iron ___ DB Dark Bronze
- ___ LB Long Beach Blue ___ UF Unfinished
- ___ CW Custom Wet ___ XX Modifier
- ___ CP Custom Powder



SPRING CITY ELECTRICAL MFG. CO., INC.
 Hall & Main Streets, P. O. Box 19
 Spring City, PA 19475-0019
 Phone: 610-948-4000 Fax: 610-948-5577
 Website: www.springcity.com

SPRING CITY

Revision 10/2008

Page: BD 5

Edgewater Bollards

Catalog No.: BDEDG-16-3.42/3.50

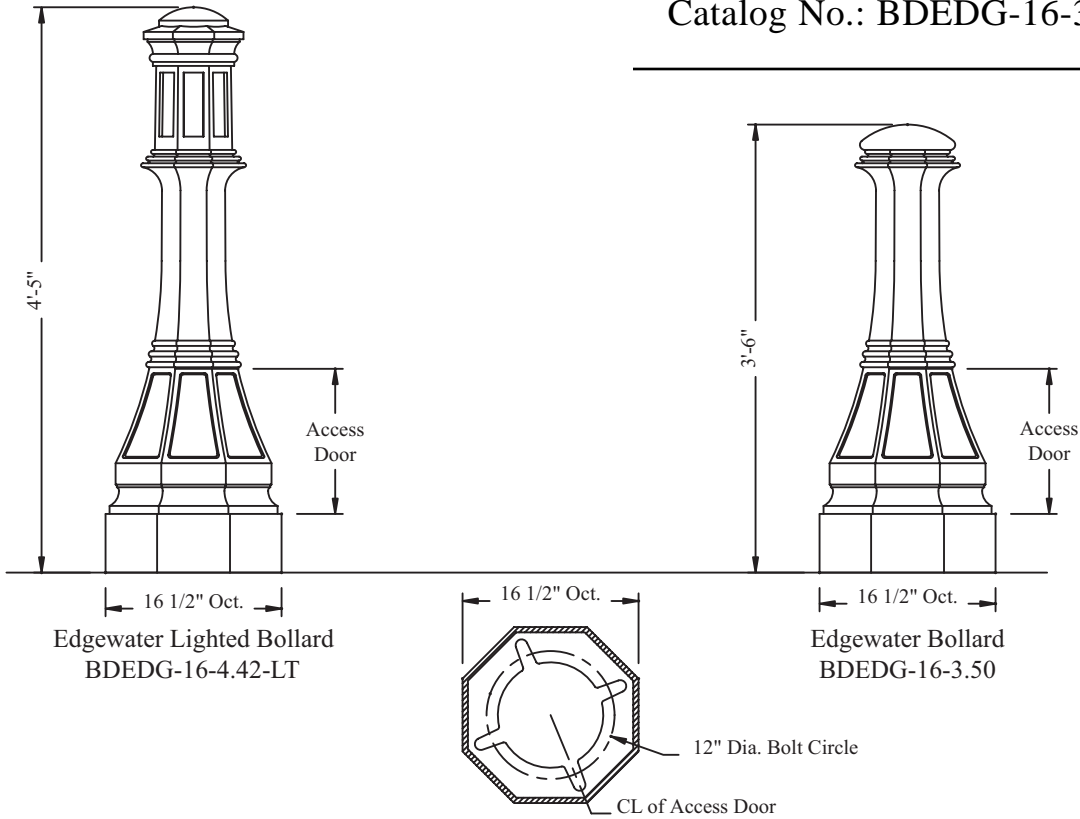

Lighted Bollard Catalog Number Example: DBDEDG-16-4.42-LT-MH050-PV1-SD-YCLO-L55-323/1NW-CB
 (Cast Ductile Iron Bollard Edgewater-16 1/2" Base Dimension-4'5" Height-Lighted-50 Watt Metal Halide-Postline Ballast 120 Volt-Medium Base Socket-Acrylic Clear Cylinder-Internal Type V Refractor-3/4" x 24" Anchor Bolts each with 1 Nut & Washer- Finish Classic Black)

Material Product Style - Base Dimension - Height (see above)-
 ___ IBDEDG-16-___(Ht)- Cast Iron Bollard Edgewater - 16 1/2" - ___ Ht-
 ___ DBDEDG-16-___(Ht)- Cast Ductile Iron Bollard Edgewater - 16 1/2" - ___ Ht-
 ___ ABDEDG-16-___(Ht)- Cast Aluminum Bollard Edgewater - 16 1/2" - ___ Ht-

Modifications

___ DD- Direct Burial ___ LT- Lighted
 ___ RM- Removable ___ EB- Eyebolt
 ___ DP- Dedication Plaque

Lamping

___ IN- Incandescent
 ___ MH035- 35 Watt Metal Halide (120 or 277 V) F-can Ballast Only
 ___ MH050- 50 Watt Metal Halide (120 V only)
 ___ MH070- 70 Watt Metal Halide (120 or 277 V) F-can Ballast Only
 ___ MH100- 100 Watt Metal Halide (120 or 277 V) F-can Ballast Only
 ___ HP035- 35 Watt High pressure sodium (120 V only)
 ___ HP050- 50 Watt High pressure sodium (120 V only)
 ___ HP070- 70 Watt High pressure sodium (120, 208, 240 or 277 V)
 ___ HP100- 100 Watt High pressure sodium (120, 208, 240 or 277 V)
 ___ CF028- 28 Watt Compact Fluorescent (120, 208, 240 or 277 V)
 ___ CF032- 32 Watt Compact Fluorescent (120, 208, 240 or 277 V)
 ___ CF042- 42 Watt Compact Fluorescent (120, 208, 240 or 277 V)

Ballast Type

___ P Postline ___ F F-can (120/277 V Only)

Voltage

___ V1 120 Volt ___ V2 240 Volt
 ___ V8 208 Volt ___ V7 277 Volt

Socket

___ SD Medium Base ___ SF Fluorescent

Cylinder

___ YCLO Clear Acrylic ___ YCLF Frosted Acrylic

Internal Refractor

___ L55 Internal Type V

Anchor Bolts:

___ 323/ 3/4" x 24" ___ 130/ 1" x 30"
 ___ 330/ 3/4" x 30" ___ 136/ 1" x 36"
 ___ 124/ 1" x 24" ___ 140/ 1" x 40"
 ___ 1NW- 1Nut & Washer / Bolt
 ___ 2NW- 2 Nuts & Washers / Bolt

Paint

___ PO Prime Only ___ CB Classic Black
 ___ BG Bottle Green ___ VG Verde Green
 ___ GI Grey Iron ___ DB Dark Bronze
 ___ LB Long Beach Blue ___ UF Unfinished
 ___ CW Custom Wet ___ XX Modifier
 ___ CP Custom Powder



SPRING CITY ELECTRICAL MFG. CO., INC.
 Hall & Main Streets, P. O. Box 19
 Spring City, PA 19475-0019
 Phone: 610-948-4000 Fax: 610-948-5577
 Website: www.springcity.com

Hancock Bollards

Catalog No.: BDHNC-16-3.46/3.67

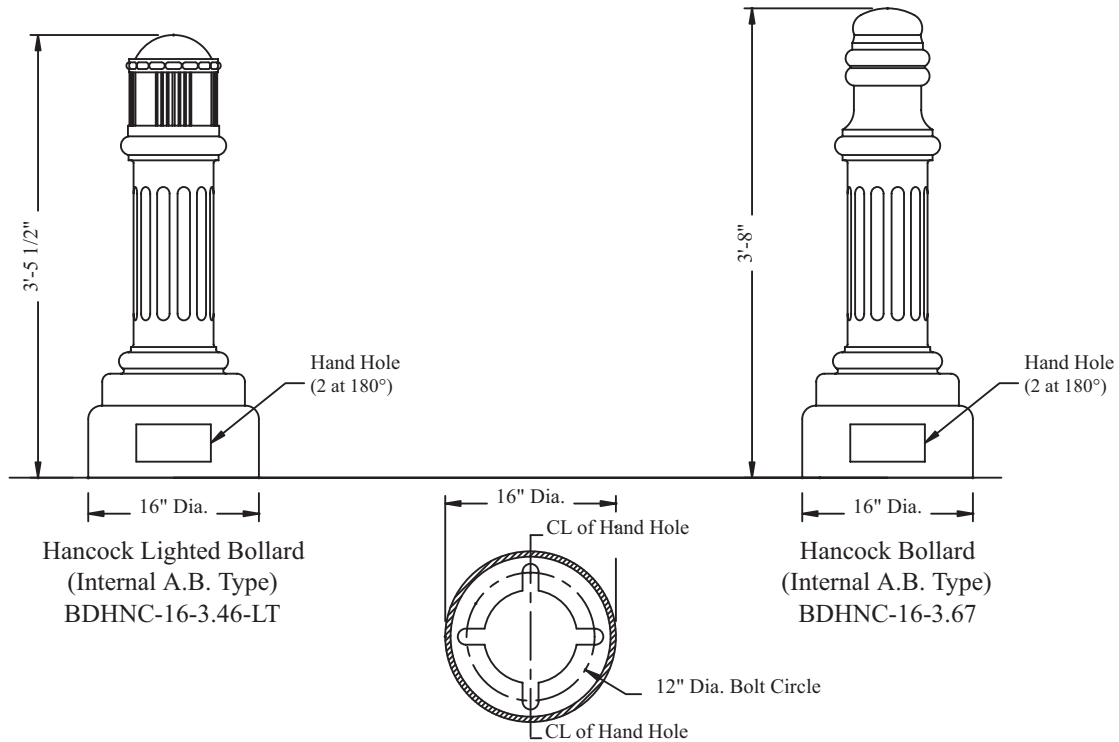

Lighted Bollard Catalog Number Example: DBDHNC-16-3.46-LT-MH050-PV1-SD-YCLO-L55-323/1NW-CB
 (Cast Ductile Iron Bollard Hancock-16" Base Dimension-3' 5 1/2" Height-Lighted-50 Watt Metal Halide-Postline Ballast 120 Volt-Medium Base Socket Acrylic Clear Cylinder-Internal Type V Refractor-3/4" x 24" Anchor Bolts each with 1 Nut & Washer- Finish Classic Black)

Material Product Style - Base Dimension - *Height* (see above)-
 ___ IBDHNC-16-___(Ht)- Cast Iron Bollard Hancock - 16" - ___ Ht-
 ___ DBDHNC-16-___(Ht)- Cast Ductile Iron Bollard Hancock - 16" - ___ Ht-
 ___ ABDHNC-16-___(Ht)- Cast Aluminum Bollard Hancock - 16" - ___ Ht-

Modifications

___ DD- Direct Burial ___ LT- Lighted
 ___ RM- Removable ___ EB- Eyebolt
 ___ DP- Dedication Plaque

Lamping

___ IN- Incandescent
 ___ MH050- 50 Watt Metal Halide (120 V only)
 ___ HP050- 50 Watt High pressure sodium (120 V only)
 ___ HP070- 70 Watt High pressure sodium (120, 208, 240 or 277 V)
 ___ HP100- 100 Watt High pressure sodium (120, 208, 240 or 277 V)
 ___ CF028- 28 Watt Compact Fluorescent (120, 208, 240 or 277 V)
 ___ CF032- 32 Watt Compact Fluorescent (120, 208, 240 or 277 V)
 ___ CF042- 42 Watt Compact Fluorescent (120, 208, 240 or 277 V)

Ballast Type

___ P Postline ___ F F-can (120/277 V Only)

Voltage

___ V1 120 Volt ___ V2 240 Volt
 ___ V8 208 Volt ___ V7 277 Volt

Socket

___ SD Medium Base ___ SF Fluorescent

Cylinder

___ YCLO Clear Acrylic ___ YCLF Frosted Acrylic

Internal Refractor

___ L55 Internal Type V

Anchor Bolts:

___ 323/ 3/4" x 24" ___ 130/ 1" x 30"
 ___ 330/ 3/4" x 30" ___ 136/ 1" x 36"
 ___ 124/ 1" x 24" ___ 140/ 1" x 40"
 ___ 1NW- 1Nut & Washer / Bolt
 ___ 2NW- 2 Nuts & Washers / Bolt

Paint

___ PO Prime Only ___ CB Classic Black
 ___ BG Bottle Green ___ VG Verde Green
 ___ GI Grey Iron ___ DB Dark Bronze
 ___ LB Long Beach Blue ___ UF Unfinished
 ___ CW Custom Wet ___ XX Modifier
 ___ CP Custom Powder



SPRING CITY ELECTRICAL MFG. CO., INC.
 Hall & Main Streets, P. O. Box 19
 Spring City, PA 19475-0019
 Phone: 610-948-4000 Fax: 610-948-5577
 Website: www.springcity.com

Hancock Bollards

Catalog No.: BDHNC-15-4.21/4.42 11-4.42

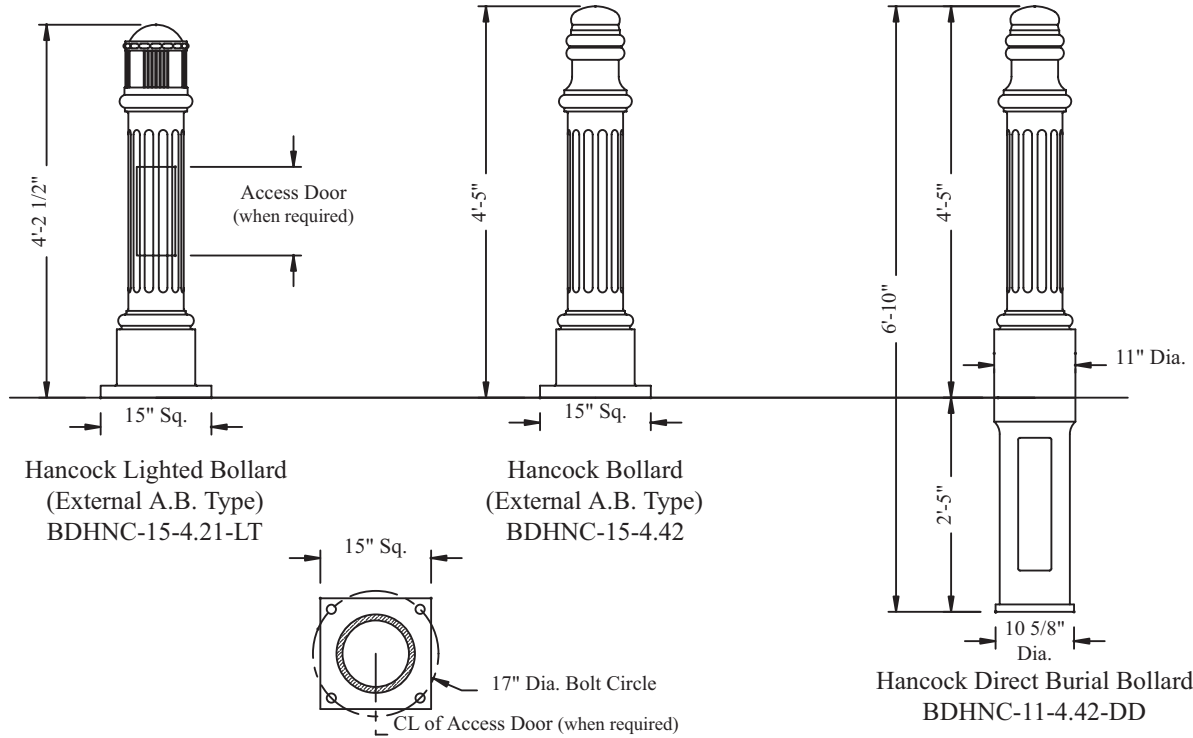

Lighted Bollard Catalog Number Example: DBDHNC-15-4.21-LT-MH050-PV1-SD-YCLO-L55-323/1NW-CB
 (Cast Ductile Iron Bollard Hancock-15" Base Dimension-4'2 1/2" Height-Lighted-50 Watt Metal Halide-Postline Ballast 120 Volt-Medium Base Socket Acrylic Clear Cylinder-Internal Type V Refractor-3/4" x 24" Anchor Bolts each with 1 Nut & Washer- Finish Classic Black)

Material Product Style - Base Dimension - Height (see above)-

- ___ IBDHNC-___-(Ht)- Cast Iron Bollard Hancock - ___" - ___ Ht-
- ___ DBDHNC-___-(Ht)- Cast Ductile Iron Bollard Hancock - ___" - ___ Ht-
- ___ ABDHNC-___-(Ht)- Cast Aluminum Bollard Hancock - ___" - ___ Ht-

Modifications

- ___ DD- Direct Burial
- ___ AC- Anchor Bolt Covers
- ___ LT- Lighted
- ___ RM- Removable
- ___ EB- Eyebolt
- ___ DP- Dedication Plaque

Lamping

- ___ IN- Incandescent
- ___ MH035- 35 Watt Metal Halide (120 or 277 V) F-can Ballast Only
- ___ MH050- 50 Watt Metal Halide (120 V only)
- ___ MH070- 70 Watt Metal Halide (120 or 277 V) F-can Ballast Only
- ___ MH100- 100 Watt Metal Halide (120 or 277 V) F-can Ballast Only
- ___ HP0035- 35 Watt High pressure sodium (120 V only)
- ___ HP050- 50 Watt High pressure sodium (120 V only)
- ___ HP070- 70 Watt High pressure sodium (120, 208, 240 or 277 V)
- ___ HP100- 100 Watt High pressure sodium (120, 208, 240 or 277 V)
- ___ CF028- 28 Watt Compact Fluorescent (120, 208, 240 or 277 V)
- ___ CF032- 32 Watt Compact Fluorescent (120, 208, 240 or 277 V)
- ___ CF042- 42 Watt Compact Fluorescent (120, 208, 240 or 277 V)

Ballast Type

- ___ P Postline
- ___ F F-can (120/277 V Only)

Voltage

- ___ V1 120 Volt
- ___ V2 240 Volt
- ___ V8 208 Volt
- ___ V7 277 Volt

Socket

- ___ SD Medium Base
- ___ SF Fluorescent

Cylinder

- ___ YCLO Clear Acrylic
- ___ YCLF Frosted Acrylic

Internal Refractor

- ___ L55 Internal Type V

Anchor Bolts:

- ___ 323/ 3/4" x 24"
- ___ 130/ 1" x 30"
- ___ 330/ 3/4" x 30"
- ___ 136/ 1" x 36"
- ___ 124/ 1" x 24"
- ___ 140/ 1" x 40"
- ___ 1NW- 1Nut & Washer / Bolt
- ___ 2NW- 2 Nuts & Washers / Bolt

Paint

- ___ PO Prime Only
- ___ CB Classic Black
- ___ BG Bottle Green
- ___ VG Verde Green
- ___ GI Grey Iron
- ___ DB Dark Bronze
- ___ LB Long Beach Blue
- ___ UF Unfinished
- ___ CW Custom Wet
- ___ XX Modifier
- ___ CP Custom Powder, advise



SPRING CITY ELECTRICAL MFG. CO., INC.

Hall & Main Streets, P. O. Box 19

Spring City, PA 19475-0019

Phone: 610-948-4000 Fax: 610-948-5577

Website: www.springcity.com

Revision 10/2008

Page: BD 8

Mount View Bollards

Catalog No.: BDMNV-12-3.58

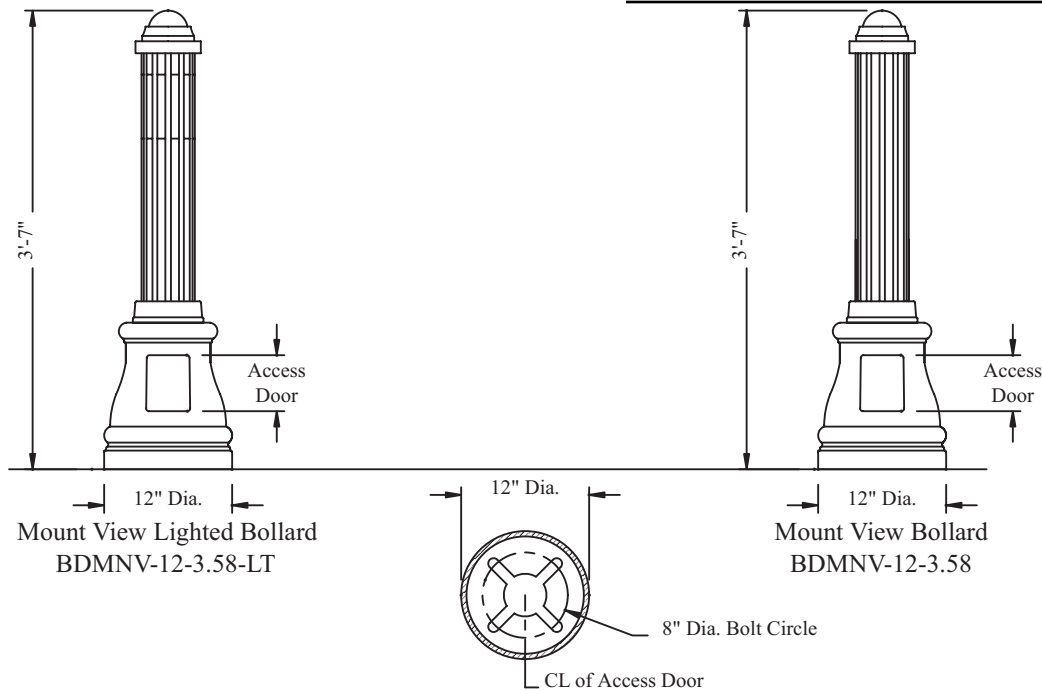

Lighted Bollard Catalog Number Example: **ABDMNV-12-3.58-LT-MH050-PV1-SD-YCLO-323/1NW-CB**
 (Cast Aluminum Bollard Mount View-12" Base Dimension-3' 7" Height-Lighted-50 Watt Metal Halide-Postline Ballast 120 Volt-Medium Base Socket Acrylic Clear Cylinder-3/4" x 24" Anchor Bolts each with 1 Nut & Washer- Finish Classic Black)

Material Product Style - Base Dimension -Height-
 ___ ABDMNV-12-3.58 - Cast Aluminum Bollard Mount View - 12" - 3' 7"

Modifications

___ DD- Direct Burial ___ LT- Lighted
 ___ RM- Removable ___ EB- Eyebolt
 ___ DP- Dedication Plaque

Lamping

___ IN- Incandescent
 ___ MH050- 50 Watt Metal Halide (120 V only)
 ___ HP035- 35 Watt High pressure sodium (120 V only)
 ___ HP050- 50 Watt High pressure sodium (120 V only)
 ___ HP070- 70 Watt High pressure sodium (120, 208, 240 or 277 V)
 ___ HP100- 100 Watt High pressure sodium (120, 208, 240 or 277 V)
 ___ CF028- 28 Watt Compact Fluorescent (120, 208, 240 or 277 V)
 ___ CF032- 32 Watt Compact Fluorescent (120, 208, 240 or 277 V)
 ___ CF042- 42 Watt Compact Fluorescent (120, 208, 240 or 277 V)

Ballast Type

___ P Postline

Voltage

___ V1 120 Volt ___ V2 240 Volt
 ___ V8 208 Volt ___ V7 277 Volt

Socket

___ SD Medium Base ___ SF Fluorescent

Cylinder

___ YCLO Clear Acrylic ___ YCLF Frosted Acrylic

Anchor Bolts:

___ 323/ 3/4" x 24" ___ 130/ 1" x 30"
 ___ 330/ 3/4" x 30" ___ 136/ 1" x 36"
 ___ 124/ 1" x 24" ___ 140/ 1" x 40"
 ___ 1NW- 1Nut & Washer / Bolt
 ___ 2NW- 2 Nuts & Washers / Bolt

Paint

___ PO Prime Only ___ CB Classic Black
 ___ BG Bottle Green ___ VG Verde Green
 ___ GI Grey Iron ___ DB Dark Bronze
 ___ LB Long Beach Blue ___ UF Unfinished
 ___ CW Custom Wet ___ XX Modifier
 ___ CP Custom Powder



SPRING CITY ELECTRICAL MFG. CO., INC.
 Hall & Main Streets, P. O. Box 19
 Spring City, PA 19475-0019
 Phone: 610-948-4000 Fax: 610-948-5577
 Website: www.springcity.com

SPRING CITY

Revision 10/2008

Page: BD 10

Mini Mariner Bollards

Catalog No.: BDMNM-12-3.58

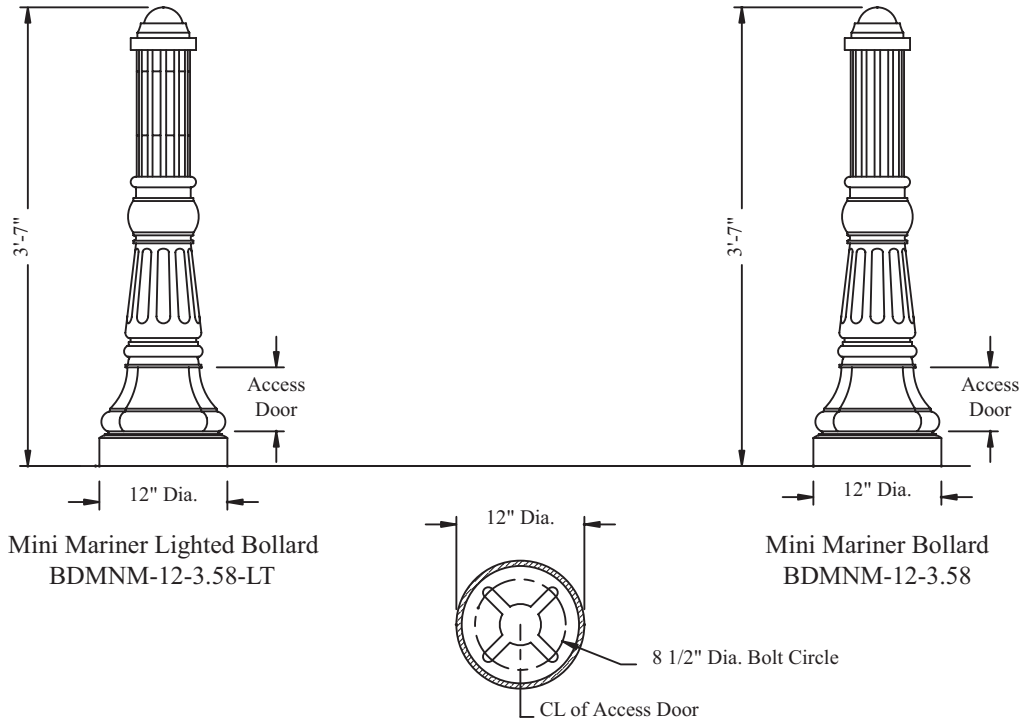

Lighted Bollard Catalog Number Example: ABDMMN-12-3.58-LT-MH050-PV1-SD-YCLO-323/1NW-CB
 (Cast Aluminum Bollard Mini Mariner-12" Base Dimension-3.6' Height-Lighted-50 Watt Metal Halide-Postline Ballast 120 Volt-Medium Base Socket-Acrylic Clear Cylinder- 3/4" x 24" Anchor Bolts each with 1 Nut & Washer- Finish Classic Black)

Material Product Style - Base Dimension - Height-

___ ABDMMN-12-3.58- Cast Aluminum Bollard Mini Mariner - 12"- 3'7"

Modifications

___ DD- Direct Burial ___ LT- Lighted
 ___ RM- Removable ___ EB- Eyebolt
 ___ DP- Dedication Plaque

Lamping

___ IN- Incandescent
 ___ MH050- 50 Watt Metal Halide (120 V only)
 ___ HP050- 50 Watt High pressure sodium (120 V only)
 ___ HP070- 70 Watt High pressure sodium (120, 208, 240 or 277 V)
 ___ HP100- 100 Watt High pressure sodium (120, 208, 240 or 277 V)
 ___ CF028- 28 Watt Compact Fluorescent (120, 208, 240 or 277 V)
 ___ CF032- 32 Watt Compact Fluorescent (120, 208, 240 or 277 V)
 ___ CF042- 42 Watt Compact Fluorescent (120, 208, 240 or 277 V)

Ballast Type

___ P Postline

Voltage

___ V1 120 Volt ___ V2 240 Volt
 ___ V8 208 Volt ___ V7 277 Volt

Socket

___ SD Medium Base ___ SF Fluorescent

Cylinder

___ YCLO Clear Acrylic ___ YCLF Frosted Acrylic

Anchor Bolts:

___ 323/ 3/4" x 24" ___ 130/ 1" x 30"
 ___ 330/ 3/4" x 30" ___ 136/ 1" x 36"
 ___ 124/ 1" x 24" ___ 140/ 1" x 40"
 ___ 1NW- 1Nut & Washer / Bolt
 ___ 2NW- 2 Nuts & Washers / Bolt

Paint

___ PO Prime Only ___ CB Classic Black
 ___ BG Bottle Green ___ VG Verde Green
 ___ GI Grey Iron ___ DB Dark Bronze
 ___ LB Long Beach Blue ___ UF Unfinished
 ___ CW Custom Wet ___ XX Modifier
 ___ CP Custom Powder



SPRING CITY ELECTRICAL MFG. CO., INC.
 Hall & Main Streets, P. O. Box 19
 Spring City, PA 19475-0019
 Phone: 610-948-4000 Fax: 610-948-5577
 Website: www.springcity.com

SPRING CITY

Station Light Bollards

Catalog No.: BDSTT-11-3.40

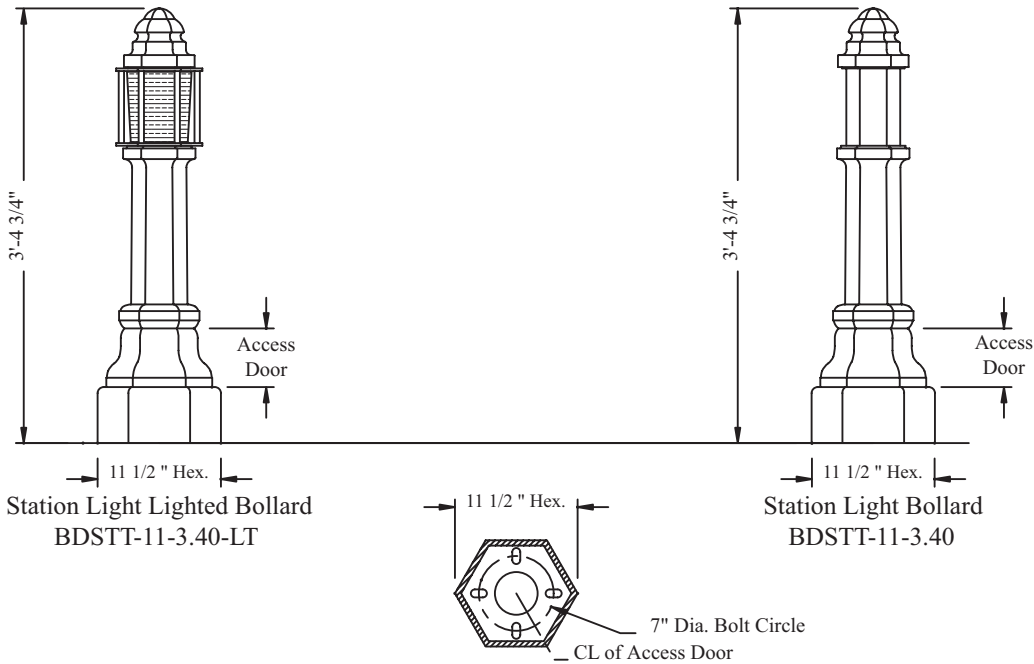

Lighted Bollard Catalog Number Example: ABDSTT-11-3.40-LT-MH050-PV1-SD-L65-323/1NW-CB

(Cast Aluminum Bollard Station Light-11 1/2" Base Dimension-3' 4 3/4" Height-Lighted-50 Watt Metal Halide-Postline Ballast 120 Volt-Medium Base Socket-Internal Type V Refractor-3/4" x 24" Anchor Bolts each with 1 Nut & Washer- Finish Classic Black)

Material Product Style - Base Dimension - Height-

___ ABDSTT-11-3.40- Cast Aluminum Bollard Station Light - 11 1/2" - 3' 4 3/4"

Modifications

___ DD- Direct Burial ___ LT- Lighted
 ___ RM- Removable ___ EB- Eyebolt
 ___ DP- Dedication Plaque

Lamping

___ IN- Incandescent
 ___ MH050- 50 Watt Metal Halide (120 V only)
 ___ HP050- 50 Watt High pressure sodium (120 V only)
 ___ HP070- 70 Watt High pressure sodium (120, 208, 240 or 277 V)
 ___ HP100- 100 Watt High pressure sodium (120, 208, 240 or 277 V)
 ___ CF028- 28 Watt Compact Fluorescent (120, 208, 240 or 277 V)
 ___ CF032- 32 Watt Compact Fluorescent (120, 208, 240 or 277 V)
 ___ CF042- 42 Watt Compact Fluorescent (120, 208, 240 or 277 V)

Ballast Type

___ P Postline

Voltage

___ V1 120 Volt ___ V2 240 Volt
 ___ V8 208 Volt ___ V7 277 Volt

Socket

___ SD Medium Base ___ SF Fluorescent

Internal Refractor

___ L65 Internal Type V

Anchor Bolts:

___ 323/ 3/4" x 24" ___ 130/ 1" x 30"
 ___ 330/ 3/4" x 30" ___ 136/ 1" x 36"
 ___ 124/ 1" x 24" ___ 140/ 1" x 40"
 ___ 1NW- 1Nut & Washer / Bolt
 ___ 2NW- 2 Nuts & Washers / Bolt

Paint

___ PO Prime Only ___ CB Classic Black
 ___ BG Bottle Green ___ VG Verde Green
 ___ GI Grey Iron ___ DB Dark Bronze
 ___ LB Long Beach Blue ___ UF Unfinished
 ___ CW Custom Wet ___ XX Modifier
 ___ CP Custom Powder, advise _____



SPRING CITY ELECTRICAL MFG. CO., INC.

Hall & Main Streets, P. O. Box 19

Spring City, PA 19475-0019

Phone: 610-948-4000 Fax: 610-948-5577

Website: www.springcity.com

SPRING CITY

Revision 10/2008

Page: BD 12

Newburyport Bollards

Catalog No.: BDNBP-13/11-3.25

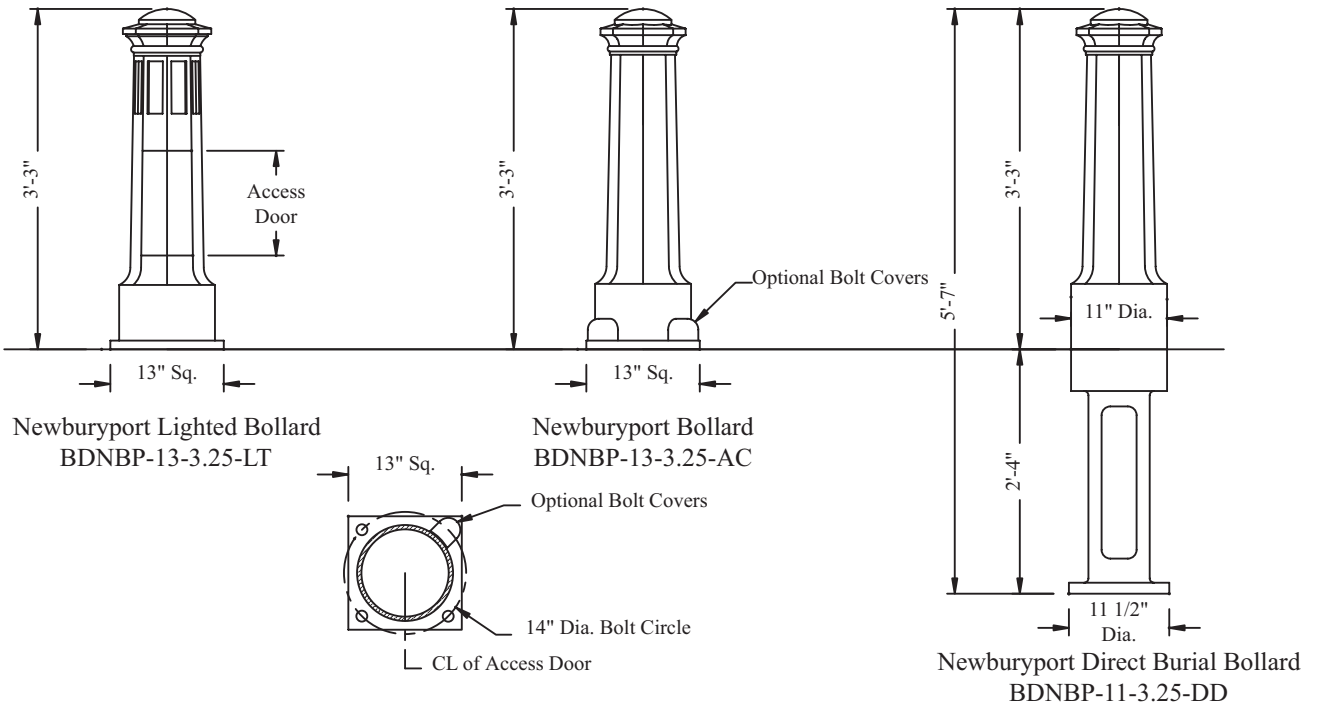

Lighted Bollard Catalog Number Example: DBDNBP-13-3.25-LT-MH050-PV1-SD-YCLO-L55-323/1NW-CB
 (Cast Ductile Iron Bollard Newburyport-13" Base Dimension-3' 3" Height-Lighted-50 Watt Metal Halide-Postline Ballast 120 Volt-Medium Base Socket- Acrylic Clear Cylinder-Internal Type V Refractor-3/4" x 24" Anchor Bolts each with 1 Nut & Washer- Finish Classic Black)

Material Product Style - Base Dimension - Height -
 ___ IBDNBP-__-3.25- Cast Iron Bollard Newburyport - __ - 3' 3"
 ___ DBDNBP-__-3.25- Cast Ductile Iron Bollard Newburyport - __ - 3' 3"
 ___ ABDNBP-__-3.25- Cast Aluminum Bollard Newburyport - __ - 3' 3"

Modifications
 ___ DD- Direct Burial ___ AC- Anchor Bolt Covers
 ___ LT- Lighted ___ RM- Removable
 ___ EB- Eyebolt ___ DP- Dedication Plaque

Lamping
 ___ IN- Incandescent
 ___ MH035- 35 Watt Metal Halide (120 or 277 V) F-can Ballast Only
 ___ MH050- 50 Watt Metal Halide (120 V only)
 ___ MH070- 70 Watt Metal Halide (120 or 277 V) F-can Ballast Only
 ___ MH100- 100 Watt Metal Halide (120 or 277 V) F-can Ballast Only
 ___ HP035- 35 Watt High pressure sodium (120 V only)
 ___ HP050- 50 Watt High pressure sodium (120 V only)
 ___ HP070- 70 Watt High pressure sodium (120, 208, 240 or 277 V)
 ___ HP100- 100 Watt High pressure sodium (120, 208, 240 or 277 V)
 ___ CF028- 28 Watt Compact Fluorescent (120, 208, 240 or 277 V)
 ___ CF032- 32 Watt Compact Fluorescent (120, 208, 240 or 277 V)
 ___ CF042- 42 Watt Compact Fluorescent (120, 208, 240 or 277 V)

Ballast Type
 ___ P Postline ___ F F-can (120/277 V only)

Voltage
 ___ V1 120 Volt ___ V2 240 Volt
 ___ V8 208 Volt ___ V7 277 Volt

Socket
 ___ SD Medium Base ___ SF Fluorescent

Cylinder
 ___ YCLO Clear Acrylic ___ YCLF Frosted Acrylic

Internal Refractor
 ___ L55 Internal Type V

Anchor Bolts:
 ___ 323/ 3/4" x 24" ___ 130/ 1" x 30"
 ___ 330/ 3/4" x 30" ___ 136/ 1" x 36"
 ___ 124/ 1" x 24" ___ 140/ 1" x 40"
 ___ 1NW- 1Nut & Washer / Bolt
 ___ 2NW- 2 Nuts & Washers / Bolt

Paint
 ___ PO Prime Only ___ CB Classic Black
 ___ BG Bottle Green ___ VG Verde Green
 ___ GI Grey Iron ___ DB Dark Bronze
 ___ LB Long Beach Blue ___ UF Unfinished
 ___ CW Custom Wet ___ XX Modifier
 ___ CP Custom Powder



SPRING CITY ELECTRICAL MFG. CO., INC.
 Hall & Main Streets, P. O. Box 19
 Spring City, PA 19475-0019
 Phone: 610-948-4000 Fax: 610-948-5577
 Website: www.springcity.com

Wayzata Bollards

Catalog No.: BDWZT-10-4.58/3.86

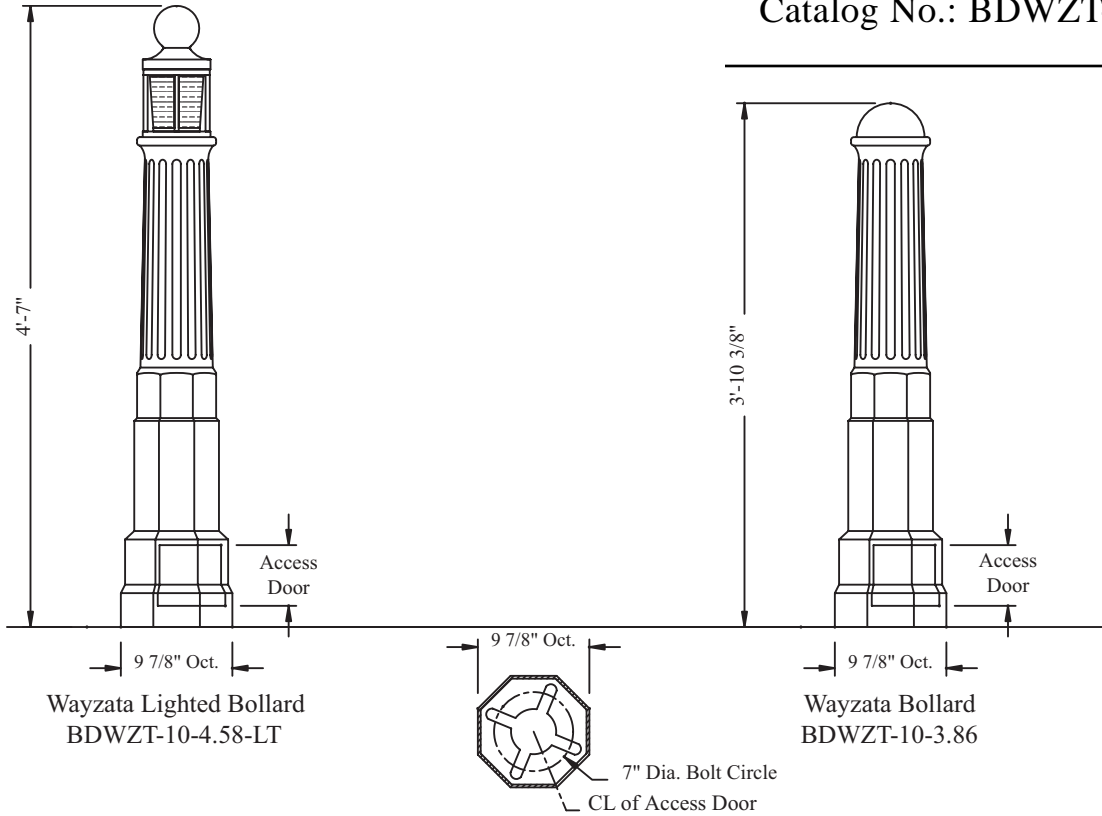

Lighted Bollard Catalog Number Example: ABDWZT-10-4.58-LT-MH050-PV1-SD-L55-323/1NW-CB
 (Cast Aluminum Bollard Wayzata-9 7/8" Base Dimension-4' 7" Height-Lighted-50 Watt Metal Halide-Postline Ballast 120 Volt-Medium Base Socket Acrylic Clear Cylinder-Internal Type V Refractor-3/4" x 24" Anchor Bolts each with 1 Nut & Washer- Finish Classic Black)

Material Product Style - Base Dimension - Height (see above)-

___ ABDWZT-10-___(Ht)- Cast Aluminum Bollard Wayzata - 9 7/8" -
 ___Ht-

Modifications

___DD- Direct Burial ___LT- Lighted
 ___RM- Removable ___EB- Eyebolt
 ___DP- Dedication Plaque

Lamping

___IN- Incandescent
 ___MH035- 35 Watt Metal Halide (120 or 277 V) F-can Ballast Only
 ___MH050- 50 Watt Metal Halide (120 V only)
 ___MH070- 70 Watt Metal Halide (120 or 277 V) F-can Ballast Only
 ___MH100- 100 Watt Metal Halide (120 or 277 V) F-can Ballast Only
 ___HP035- 35 Watt High pressure sodium (120 V only)
 ___HP050- 50 Watt High pressure sodium (120 V only)
 ___HP070- 70 Watt High pressure sodium (120, 208, 240 or 277 V)
 ___HP100- 100 Watt High pressure sodium (120, 208, 240 or 277 V)
 ___CF028- 28 Watt Compact Fluorescent (120, 208, 240 or 277 V)
 ___CF032- 32 Watt Compact Fluorescent (120, 208, 240 or 277 V)
 ___CF042- 42 Watt Compact Fluorescent (120, 208, 240 or 277 V)

Ballast Type

___P Postline ___F F-can (120/277 V Only)

Voltage

___V1 120 Volt ___V2 240 Volt
 ___V8 208 Volt ___V7 277 Volt

Socket

___SD Medium Base ___SF Fluorescent

Internal Refractor

___L55 Internal Type V

Anchor Bolts:

___323/ 3/4" x 24" ___130/ 1" x 30"
 ___330/ 3/4" x 30" ___136/ 1" x 36"
 ___124/ 1" x 24" ___140/ 1" x 40"
 ___1NW- 1Nut & Washer / Bolt
 ___2NW- 2 Nuts & Washers / Bolt

Paint

___PO Prime Only ___CB Classic Black
 ___BG Bottle Green ___VG Verde Green
 ___GI Grey Iron ___DB Dark Bronze
 ___LB Long Beach Blue ___UF Unfinished
 ___CW Custom Wet ___XX Modifier
 ___CP Custom Powder



SPRING CITY ELECTRICAL MFG. CO., INC.

Hall & Main Streets, P. O. Box 19

Spring City, PA 19475-0019

Phone: 610-948-4000 Fax: 610-948-5577

Website: www.springcity.com

SPRING CITY

Revision 10/2008

Page: BD 14

Princeton Bollards
 Catalog No.: BDPRC-12-4.17/3.58
 10-3.58

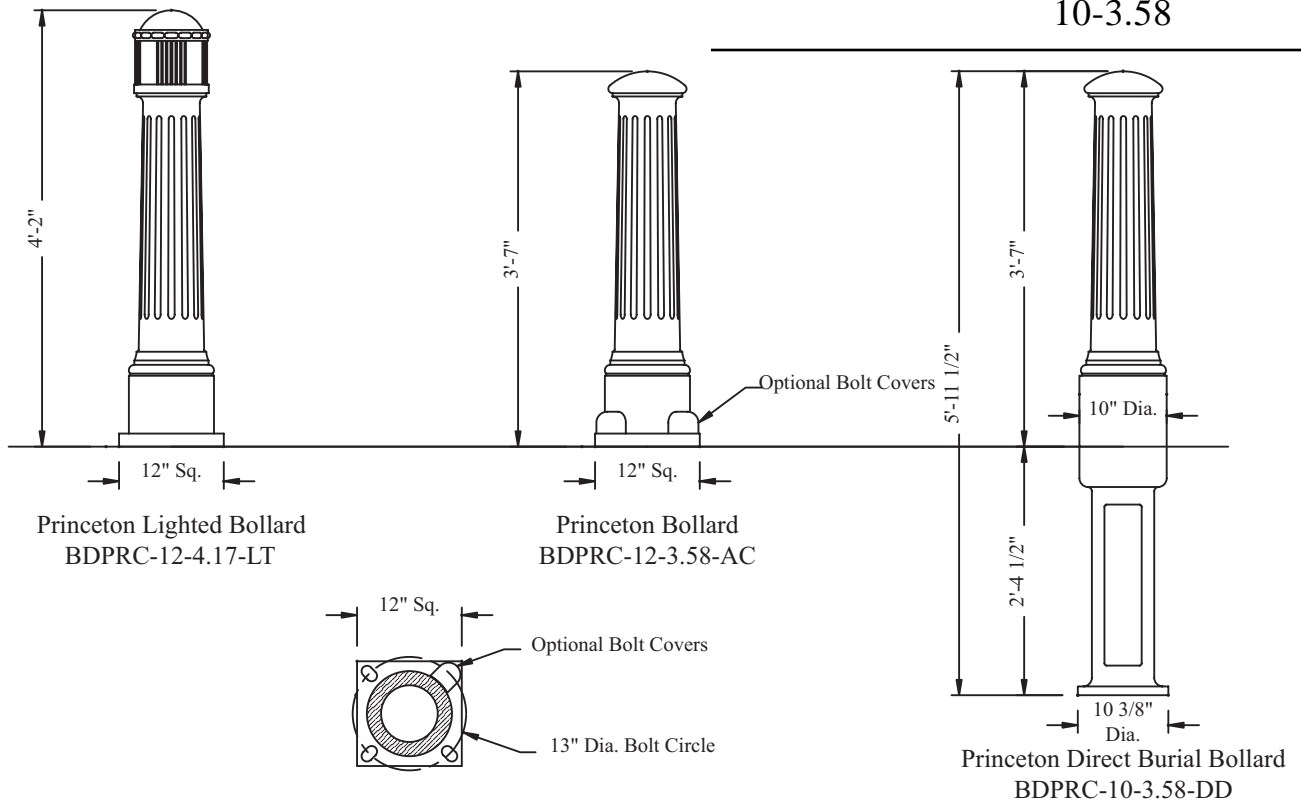

Lighted Bollard Catalog Number Example: DBDPRC-12-4.17-LT-MH050-PV1-SD-YCLO-L55-323/1NW-CB
 (Cast Ductile Iron Bollard Princeton-12" Base Dimension-4'2" Height-Lighted-50 Watt Metal Halide-Postline Ballast 120 Volt-Medium Base Socket- Acrylic Clear Cylinder-Internal Type V Refractor-3/4" x 24" Anchor Bolts each with 1 Nut & Washer- Finish Classic Black)

Material Product Style - Base Dimension - Height (see above) -
 ___ IBDPRC-___(Ht)- Cast Iron Bollard Princeton - 12" - ___Ht-
 ___ DBDPRC-___(Ht)- Cast Ductile Iron Bollard Princeton - 12" - ___Ht-
 ___ ABDPRC-___(Ht)- Cast Aluminum Bollard Princeton - 12" - ___Ht-

Modifications
 ___ DD- Direct Burial ___ AC- Anchor Bolt Covers
 ___ LT- Lighted ___ RM- Removable
 ___ EB- Eyebolt ___ DP- Dedication Plaque

Lamping
 ___ IN- Incandescent
 ___ MH035- 35 Watt Metal Halide (120 or 277 V) F-can Ballast Only
 ___ MH050- 50 Watt Metal Halide (120 V only)
 ___ MH070- 70 Watt Metal Halide (120 or 277 V) F-can Ballast Only
 ___ MH100- 100 Watt Metal Halide (120 or 277 V) F-can Ballast Only
 ___ HP035- 35 Watt High pressure sodium (120 V only)
 ___ HP050- 50 Watt High pressure sodium (120 V only)
 ___ HP070- 70 Watt High pressure sodium (120, 208, 240 or 277 V)
 ___ HP100- 100 Watt High pressure sodium (120, 208, 240 or 277 V)
 ___ CF028- 28 Watt Compact Fluorescent (120, 208, 240 or 277 V)
 ___ CF032- 32 Watt Compact Fluorescent (120, 208, 240 or 277 V)
 ___ CF042- 42 Watt Compact Fluorescent (120, 208, 240 or 277 V)

Ballast Type
 ___ P Postline ___ F F-can (120/277 Volts Only)

Voltage
 ___ V1 120 Volt ___ V2 240 Volt
 ___ V8 208 Volt ___ V7 277 Volt

Socket
 ___ SD Medium Base ___ SF Fluorescent

Cylinder
 ___ YCLO Clear Acrylic ___ YCLF Frosted Acrylic

Internal Refractor
 ___ L55 Internal Type V

Anchor Bolts:
 ___ 323/ 3/4" x 24" ___ 130/ 1" x 30"
 ___ 330/ 3/4" x 30" ___ 136/ 1" x 36"
 ___ 124/ 1" x 24" ___ 140/ 1" x 40"
 ___ 1NW- 1Nut & Washer / Bolt
 ___ 2NW- 2 Nuts & Washers / Bolt

Paint
 ___ PO Prime Only ___ CB Classic Black
 ___ BG Bottle Green ___ VG Verde Green
 ___ GI Grey Iron ___ DB Dark Bronze
 ___ LB Long Beach Blue ___ UF Unfinished
 ___ CW Custom Wet ___ XX Modifier
 ___ CP Custom Powder

OSU Bollard

Catalog No.: BDOSU-18-3.50

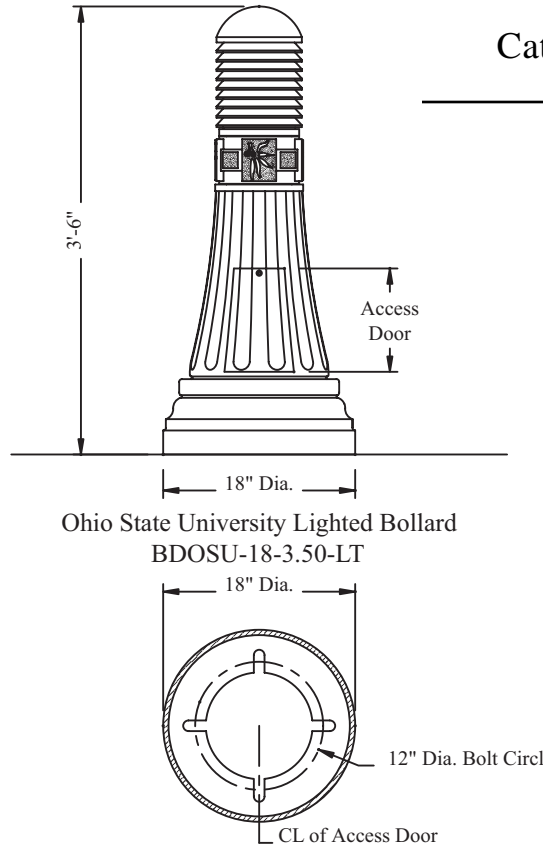

Ohio State University Lighted Bollard
BDOSU-18-3.50-LT

Lighted Bollard Catalog Number Example: DBDOSU-18-3.50-LT-MH050-PV1-SD-323/1NW-CB

(Cast Ductile Iron Bollard OSU-18" Base Dimension-3'6" Height-Lighted-50 Watt Metal Halide-Postline Ballast 120 Volt-Medium Base Socket-3/4" x 24" Anchor Bolts each with 1 Nut & Washer- Finish Classic Black)

Material Product Style - Base Dimension - Height-

- IBDOSU-18-3.50- Cast Iron Bollard OSU - 18" - 3'6"
- DBDOSU-18-3.50- Cast Ductile Iron Bollard OSU - 18" - 3'6"
- ABDOSU-18-3.50- Cast Aluminum Bollard OSU - 18" - 3'6"

Modifications

- LT- Lighted EB- Eyebolt
- DP- Dedication Plaque

Lamping

- IN- Incandescent
- MH050- 50 Watt Metal Halide (120 V only)
- HP050- 50 Watt High pressure sodium (120 V only)
- HP070- 70 Watt High pressure sodium (120, 208, 240 or 277 V)
- HP100- 100 Watt High pressure sodium (120, 208, 240 or 277 V)
- CF028- 28 Watt Compact Fluorescent (120, 208, 240 or 277 V)
- CF032- 32 Watt Compact Fluorescent (120, 208, 240 or 277 V)
- CF042- 42 Watt Compact Fluorescent (120, 208, 240 or 277 V)

Ballast Type

- P Postline

Voltage

- V1 120 Volt V2 240 Volt
- V8 208 Volt V7 277 Volt

Socket

- SD Medium Base SF Fluorescent

Anchor Bolts:

- 323/ 3/4" x 24" 130/ 1" x 30"
- 330/ 3/4" x 30" 136/ 1" x 36"
- 124/ 1" x 24" 140/ 1" x 40"
- 1NW- 1Nut & Washer / Bolt
- 2NW- 2 Nuts & Washers / Bolt

Paint

- PO Prime Only CB Classic Black
- BG Bottle Green VG Verde Green
- GI Grey Iron DB Dark Bronze
- LB Long Beach Blue UF Unfinished
- CW Custom Wet XX Modifier
- CP Custom Powder, advise _____



SPRING CITY ELECTRICAL MFG. CO., INC.

Hall & Main Streets, P. O. Box 19

Spring City, PA 19475-0019

Phone: 610-948-4000 Fax: 610-948-5577

Website: www.springcity.com

Northampton Bollard

Catalog No.: BDNRT-20-3.81/12-3.04

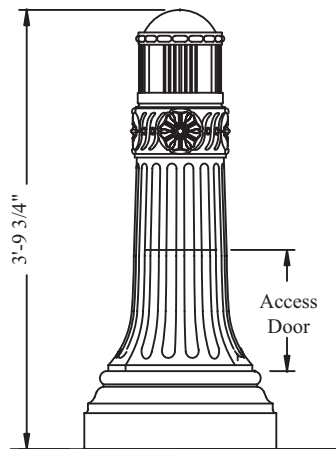

Northampton Lighted Bollard
BDNRT-20-3.81-LT

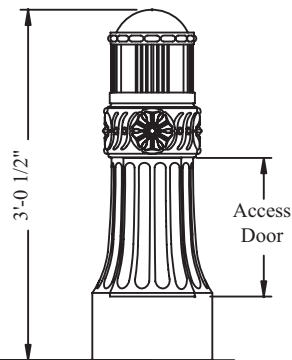
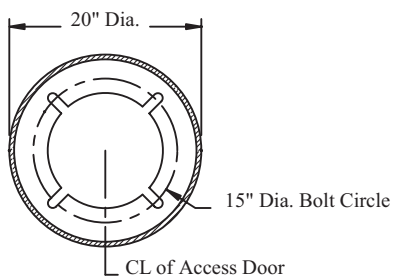

Northampton Lighted Bollard
BDNRT-12-3.04-LT

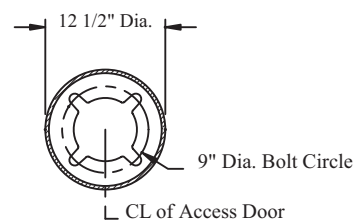

Lighted Bollard Catalog Number Example: DBDNRT-20-3.81-LT-MH050-PV1-SD-YCLO-L55-323/1NW-CB
(Cast Ductile Iron Bollard Northampton-20" Base Dimension-3' 9 3/4" Height-Lighted-50 Watt Metal Halide-Postline Ballast 120 Volt- Medium Base Socket- Acrylic Clear Cylinder-Internal Type V Refractor-3/4" x 24" Anchor Bolts each with 1 Nut & Washer- Finish Classic Black)

Material Product Style - Base Dimension - Height -

- IBDNRT-__-__(Ht) Cast Iron Bollard Northampton -__-__(Ht)
 DBDNRT-__-__(Ht) Cast Ductile Iron Bollard Northampton -__-__(Ht)
 ABDNRT-__-__(Ht) Cast Aluminum Bollard Northampton-__-__(Ht)

Modifications

- LT- Lighted EB- Eyebolt
 DP- Dedication Plaque

Lamping

- IN- Incandescent
 MH035- 35 Watt Metal Halide (120 or 277 V) F-can Ballast Only
 MH050- 50 Watt Metal Halide (120 V only)
 MH070- 70 Watt Metal Halide (120 or 277 V) F-can Ballast Only
 MH100- 100 Watt Metal Halide (120 or 277 V) F-can Ballast Only
 HP035- 35 Watt High pressure sodium (120 V only)
 HP050- 50 Watt High pressure sodium (120 V only)
 HP070- 70 Watt High pressure sodium (120, 208, 240 or 277 V)
 HP100- 100 Watt High pressure sodium (120, 208, 240 or 277 V)
 CF028- 28 Watt Compact Fluorescent (120, 208, 240 or 277 V)
 CF032- 32 Watt Compact Fluorescent (120, 208, 240 or 277 V)
 CF042- 42 Watt Compact Fluorescent (120, 208, 240 or 277 V)

Ballast Type

- P Postline F F-can (120/277 Volts Only)

Voltage

- V1 120 Volt V2 240 Volt
 V8 208 Volt V7 277 Volt

Socket

- SD Medium Base SF Fluorescent

Cylinder

- YCLO Clear Acrylic YCLF Frosted Acrylic

Internal Refractor

- L55 Internal Type V

Anchor Bolts:

- 323/ 3/4" x 24" 130/ 1" x 30"
 330/ 3/4" x 30" 136/ 1" x 36"
 124/ 1" x 24" 140/ 1" x 40"
 1NW- 1Nut & Washer / Bolt
 2NW- 2 Nuts & Washers / Bolt

Paint

- PO Prime Only CB Classic Black
 BG Bottle Green VG Verde Green
 GI Grey Iron DB Dark Bronze
 LB Long Beach Blue UF Unfinished
 CW Custom Wet XX Modifier
 CP Custom Powder



SPRING CITY ELECTRICAL MFG. CO., INC.

Hall & Main Streets, P. O. Box 19

Spring City, PA 19475-0019

Phone: 610-948-4000 Fax: 610-948-5577

Website: www.springcity.com

Revision 10/2008

Page: BD 17

Radnor Bollard

Catalog No.: BDRDN-10-4.30/3.88

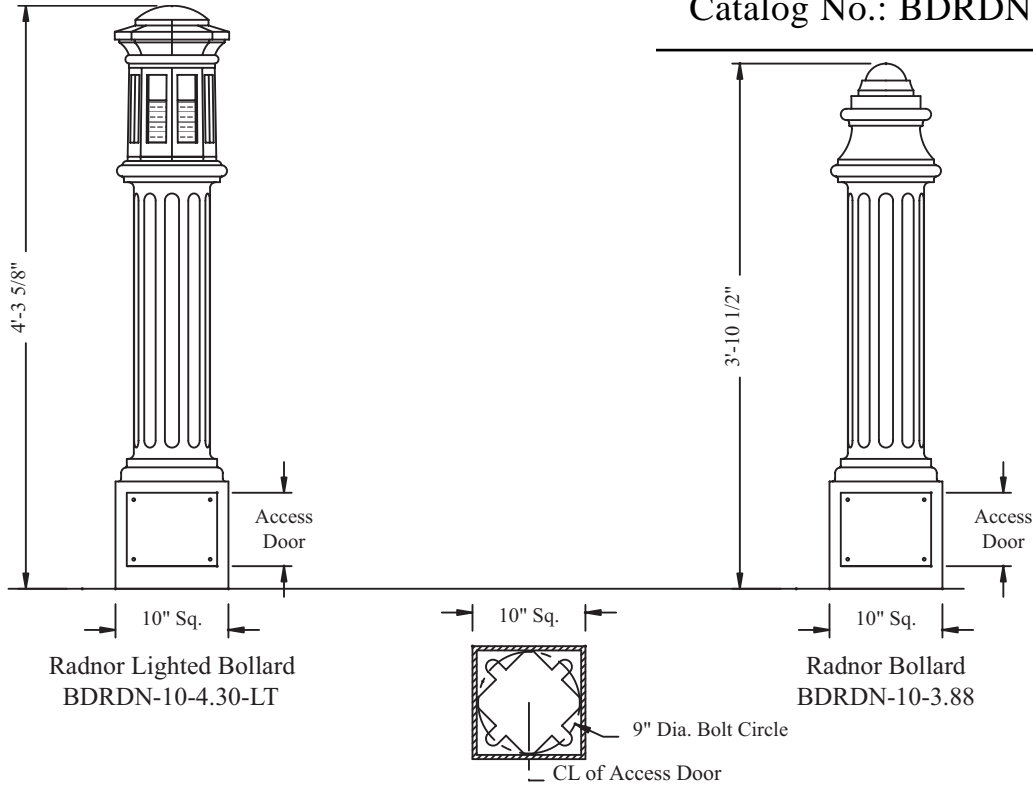

Catalog Number Example: DBDRDN-10-4.30-LT-HP100/PV8/SD-YCLO-L55-323/1NW-CB
 (Cast Ductile Iron Bollard Radnor-10" Base Dimension-4'-3 5/8" Height-Lighted-100 Watt High Pressure Sodium- Postline Ballast 208 Volt-Medium Base Socket-Acrylic Clear Cylinder-Internal Type V Refractor-3/4" x 24" Anchor Bolts each with 1 Nut & Washer- Finish Classic Black)

Material Product Style - Base Dimension - Height -

- ___ IBDRDN-10-___ Cast Iron Bollard Radnor - 10" ___ Ht
- ___ DBDRDN-10-___ Cast Ductile Iron Bollard Radnor - 10" ___ Ht
- ___ ABDRDN-10-___ Cast Aluminum Bollard Radnor - 10" ___ Ht

Modifications

- ___ DD- Direct Burial
- ___ RM- Removable
- ___ LT- Lighted
- ___ EB- Eyebolt
- ___ DP- Dedication Plaque

Lamping

- ___ IN- Incandescent
- ___ MH035- 35 Watt Metal Halide (120 or 277 V) F-can Ballast Only
- ___ MH050- 50 Watt Metal Halide (120 V only)
- ___ MH070- 70 Watt Metal Halide (120 or 277 V) F-can Ballast Only
- ___ MH100- 100 Watt Metal Halide (120 or 277 V) F-can Ballast Only
- ___ HP035- 35 Watt High pressure sodium (120 V only)
- ___ HP050- 50 Watt High pressure sodium (120 V only)
- ___ HP070- 70 Watt High pressure sodium (120, 208, 240 or 277 V)
- ___ HP100- 100 Watt High pressure sodium (120, 208, 240 or 277 V)
- ___ CF028- 28 Watt Compact Fluorescent (120, 208, 240 or 277 V)
- ___ CF032- 32 Watt Compact Fluorescent (120, 208, 240 or 277 V)
- ___ CF042- 42 Watt Compact Fluorescent (120, 208, 240 or 277 V)

Ballast Type

- ___ P Postline
- ___ F F-can (120/277 Volts Only)

Voltage

- ___ V1 120 Volt
- ___ V2 240 Volt
- ___ V8 208 Volt
- ___ V7 277 Volt

Socket

- ___ SD Medium Base
- ___ SF Fluorescent

Cylinder

- ___ YCLO Clear Acrylic
- ___ YCLF Frosted Acrylic

Internal Refractor

- ___ L55 Internal Type V

Anchor Bolts:

- ___ 323/ 3/4" x 24"
- ___ 130/ 1" x 30"
- ___ 330/ 3/4" x 30"
- ___ 136/ 1" x 36"
- ___ 124/ 1" x 24"
- ___ 140/ 1" x 40"
- ___ 1NW- 1Nut & Washer / Bolt
- ___ 2NW- 2 Nuts & Washers / Bolt

Paint

- ___ PO Prime Only
- ___ CB Classic Black
- ___ BG Bottle Green
- ___ VG Verde Green
- ___ GI Grey Iron
- ___ DB Dark Bronze
- ___ LB Long Beach Blue
- ___ UF Unfinished
- ___ CW Custom Wet
- ___ XX Modifier
- ___ CP Custom Powder



SPRING CITY ELECTRICAL MFG. CO., INC.

Hall & Main Streets, P. O. Box 19

Spring City, PA 19475-0019

Phone: 610-948-4000 Fax: 610-948-5577

Website: www.springcity.com

Revision 10/2008

Page: BD 18

Wellington Bollards

Catalog No.: BDWLG-10-3.07/2.54/3.00

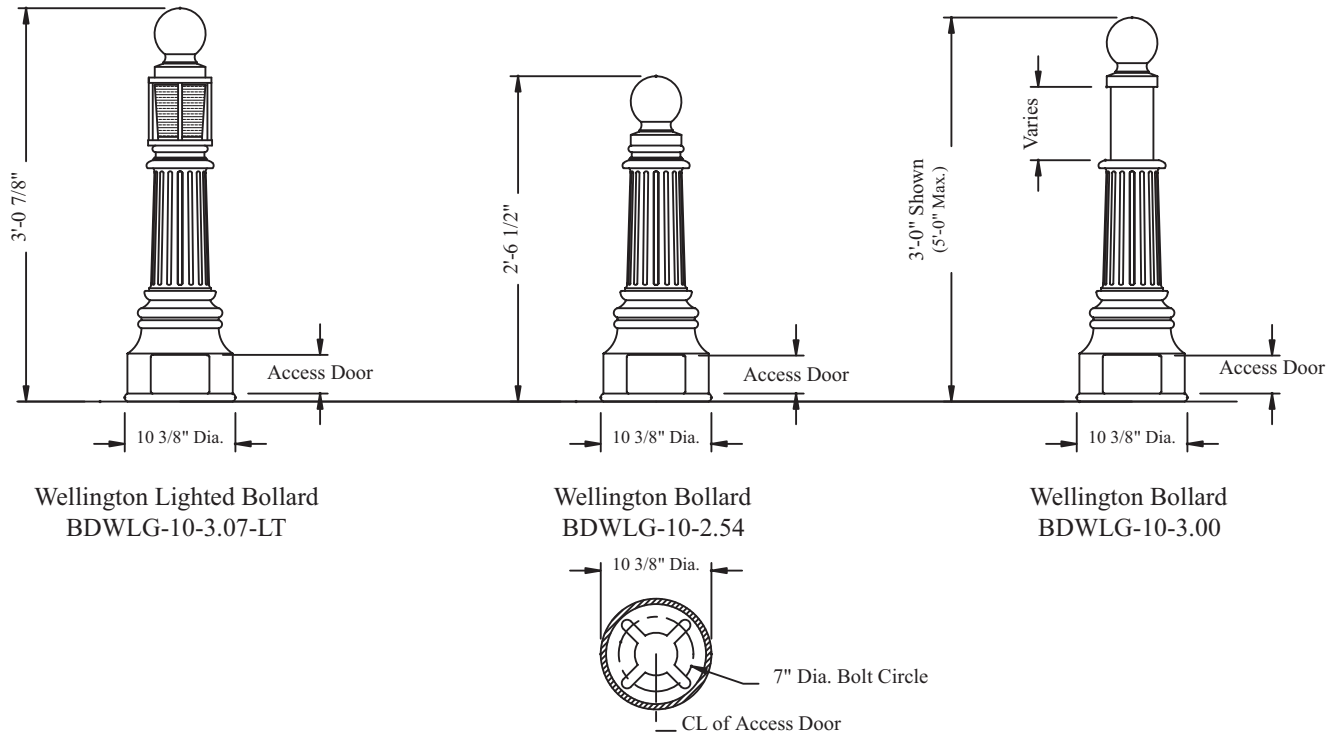

Lighted Bollard Catalog Number Example: ABDWLG-10-3.07-LT-MH050-PV1-SD-L55-323/1NW-CB
 (Cast Aluminum Bollard Wellington-10 3/8" Base Dimension-3.' 0 7/8" Height-Lighted-50 Watt Metal Halide-Postline Ballast 120 Volt-Medium Base Socket-Internal Type V Refractor-3/4" x 24" Anchor Bolts each with 1 Nut & Washer- Finish Classic Black)

Material Product Style - Base Dimension - Height (see above)-

___ ABDWLG-10-___(Ht) Cast Aluminum Bollard Wellington -10 3/8"-___
 Ht

Modifications

___ DD- Direct Burial ___ LT- Lighted
 ___ RM- Removable ___ EB- Eyebolt
 ___ DP- Dedication Plaque

Lamping

___ IN- Incandescent
 ___ MH050- 50 Watt Metal Halide (120 V only)
 ___ HP050- 50 Watt High pressure sodium (120 V only)
 ___ HP070- 70 Watt High pressure sodium (120, 208, 240 or 277 V)
 ___ HP100- 100 Watt High pressure sodium (120, 208, 240 or 277 V)
 ___ CF028- 28 Watt Compact Fluorescent (120, 208, 240 or 277 V)
 ___ CF032- 32 Watt Compact Fluorescent (120, 208, 240 or 277 V)
 ___ CF042- 42 Watt Compact Fluorescent (120, 208, 240 or 277 V)

Ballast Type

___ P Postline

Voltage

___ V1 120 Volt ___ V2 240 Volt
 ___ V8 208 Volt ___ V7 277 Volt

Socket

___ SD Medium Base ___ SF Fluorescent

Internal Refractor

___ L55 Internal Type V

Anchor Bolts:

___ 323/ 3/4" x 24" ___ 130/ 1" x 30"
 ___ 330/ 3/4" x 30" ___ 136/ 1" x 36"
 ___ 124/ 1" x 24" ___ 140/ 1" x 40"
 ___ 1NW- 1Nut & Washer / Bolt
 ___ 2NW- 2 Nuts & Washers / Bolt

Paint

___ PO Prime Only ___ CB Classic Black
 ___ BG Bottle Green ___ VG Verde Green
 ___ GI Grey Iron ___ DB Dark Bronze
 ___ LB Long Beach Blue ___ UF Unfinished
 ___ CW Custom Wet ___ XX Modifier
 ___ CP Custom Powder



SPRING CITY ELECTRICAL MFG. CO., INC.
 Hall & Main Streets, P. O. Box 19
 Spring City, PA 19475-0019
 Phone: 610-948-4000 Fax: 610-948-5577
 Website: www.springcity.com

Barcelona Bollards

Catalog No.: BDBRC-10-3.38/2.88

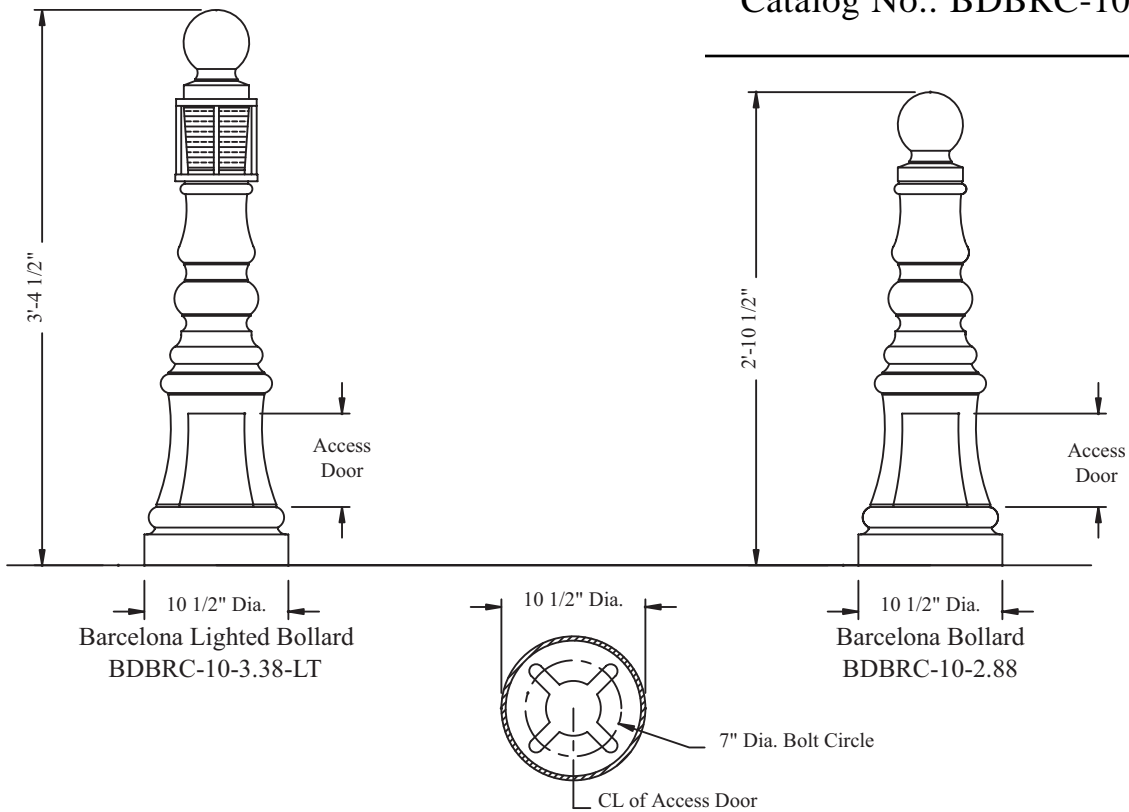

Lighted Bollard Catalog Number Example: ABDBRC-10-3.38-LT-MH050-PV1-SD-L55-323/1NW-CB
 (Cast Aluminum Bollard Barcelona-10 1/2" Base Dimension-3' 4 1/2" Height-Lighted-50 Watt Metal Halide-Postline Ballast 120 Volt-Medium Base Socket-Internal Type V Refractor-3/4" x 24" Anchor Bolts each with 1 Nut & Washer- Finish Classic Black)

Material Product Style - Base Dimension - Height (see above)-

___ ABDBRC-10-___(Ht)- Cast Aluminum Bollard Barcelona - 10 1/2" - ___ Ht

Modifications

___ DD- Direct Burial ___ LT- Lighted
 ___ RM- Removable ___ EB- Eyebolt
 ___ DP- Dedication Plaque

Lamping

___ IN- Incandescent
 ___ MH050- 50 Watt Metal Halide (120 V only)
 ___ HP050- 50 Watt High pressure sodium (120 V only)
 ___ HP070- 70 Watt High pressure sodium (120, 208, 240 or 277 V)
 ___ HP100- 100 Watt High pressure sodium (120, 208, 240 or 277 V)
 ___ CF028- 28 Watt Compact Fluorescent (120, 208, 240 or 277 V)
 ___ CF032- 32 Watt Compact Fluorescent (120, 208, 240 or 277 V)
 ___ CF042- 42 Watt Compact Fluorescent (120, 208, 240 or 277 V)

Ballast Type

___ P Postline

Voltage

___ V1 120 Volt ___ V2 240 Volt
 ___ V8 208 Volt ___ V7 277 Volt

Socket

___ SD Medium Base ___ SF Fluorescent

Internal Refractor

___ L55 Internal Type V

Anchor Bolts:

___ 323/ 3/4" x 24" ___ 130/ 1" x 30"
 ___ 330/ 3/4" x 30" ___ 136/ 1" x 36"
 ___ 124/ 1" x 24" ___ 140/ 1" x 40"
 ___ 1NW- 1Nut & Washer / Bolt
 ___ 2NW- 2 Nuts & Washers / Bolt

Paint

___ PO Prime Only ___ CB Classic Black
 ___ BG Bottle Green ___ VG Verde Green
 ___ GI Grey Iron ___ DB Dark Bronze
 ___ LB Long Beach Blue ___ UF Unfinished
 ___ CW Custom Wet ___ XX Modifier
 ___ CP Custom Powder, advise _____



SPRING CITY ELECTRICAL MFG. CO., INC.
 Hall & Main Streets, P. O. Box 19
 Spring City, PA 19475-0019
 Phone: 610-948-4000 Fax: 610-948-5577
 Website: www.springcity.com

Reston Bollard

Catalog No.: BDRST-12-3.08

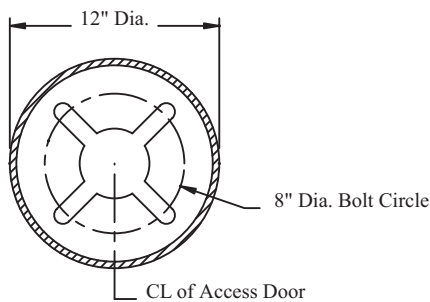
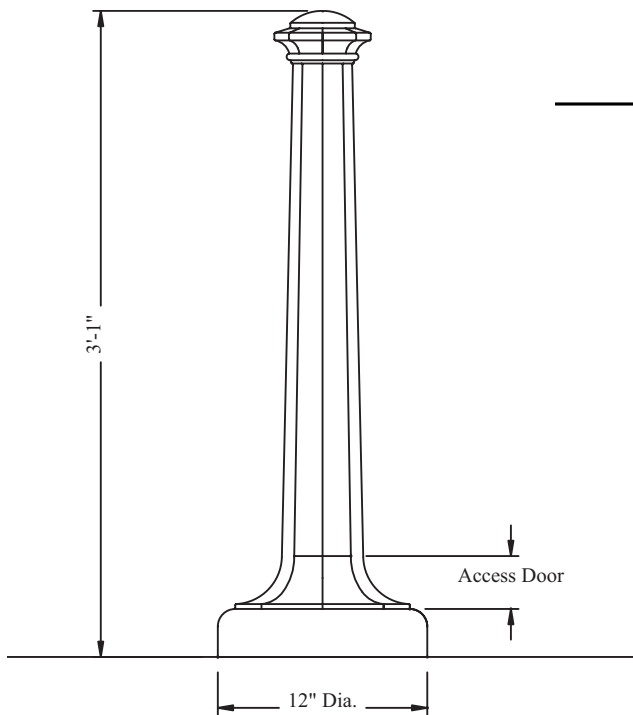

Catalog Number Example: DBDRST-12-3.08-323/1NW-CB

(Cast Ductile Iron Bollard Reston-12" Base Dimension-3'1" Height-3/4" x 24" Anchor Bolts each with 1 Nut & Washer- Finish Classic Black)

Material Product Style - Base Dimension - Height -

- ___ IBDRST-12-3.08- Cast Iron Bollard Reston - 12" - 3' 1"
- ___ DBDRST-12-3.08- Cast Ductile Iron Bollard Reston - 12" - 3' 1"
- ___ ABRST-12-3.08- Cast Aluminum Bollard Reston - 12" - 3' 1"

Modifications

- ___ DD- Direct Burial
- ___ RM- Removable
- ___ EB- Eyebolt
- ___ DP- Dedication Plaque

Anchor Bolts:

- | | |
|----------------------------------|-------------------|
| ___ 323/ 3/4" x 24" | ___ 130/ 1" x 30" |
| ___ 330/ 3/4" x 30" | ___ 136/ 1" x 36" |
| ___ 124/ 1" x 24" | ___ 140/ 1" x 40" |
| ___ 1NW- 1Nut & Washer / Bolt | |
| ___ 2NW- 2 Nuts & Washers / Bolt | |

Paint

- | | |
|------------------------|----------------------|
| ___ PO Prime Only | ___ CB Classic Black |
| ___ BG Bottle Green | ___ VG Verde Green |
| ___ GI Grey Iron | ___ DB Dark Bronze |
| ___ LB Long Beach Blue | ___ UF Unfinished |
| ___ CW Custom Wet | ___ XX Modifier |
| ___ CP Custom Powder | |



SPRING CITY ELECTRICAL MFG. CO., INC.
 Hall & Main Streets, P. O. Box 19
 Spring City, PA 19475-0019
 Phone: 610-948-4000 Fax: 610-948-5577
 Website: www.springcity.com

SPRING CITY

Revision 10/2008

Page: BD 21

Twin Lakes Bollards

Catalog No.: BDTWL-10-2.00/3.00

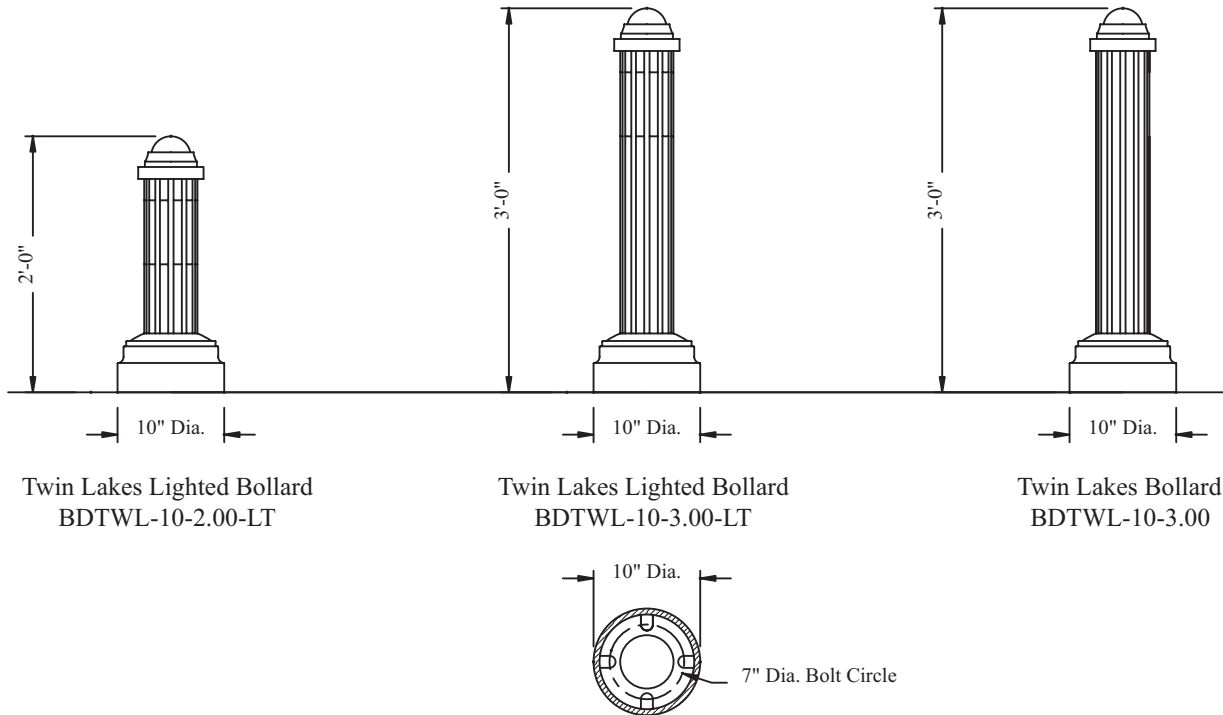

Twin Lakes Lighted Bollard
BDTWL-10-2.00-LT

Twin Lakes Lighted Bollard
BDTWL-10-3.00-LT

Twin Lakes Bollard
BDTWL-10-3.00

Lighted Bollard Catalog Number Example: ABDTWL-10-3.00-LT-MH050-PV1-SD-YCLO-323/1NW-CB
(Cast Aluminum Bollard Twin Lakes -10" Base Dimension- 3' 0" Height-Lighted-50 Watt Metal Halide-Postline Ballast 120 Volt-Medium Base Socket-Acrylic Clear Cylinder-3/4" x 24" Anchor Bolts each with 1 Nut & Washer- Finish Classic Black)

Material Product Style - Base Dimension - Height (see above)-

___ ABDTWL-10-___(Ht)- Cast Aluminum Bollard Twin Lakes - 10"-
___Ht-

Modifications

___ DD- Direct Burial ___ LT- Lighted
___ RM- Removable ___ EB- Eyebolt
___ DP- Dedication Plaque

Lamping

___ IN- Incandescent
___ MH050- 50 Watt Metal Halide (120 V only)
___ HP050- 50 Watt High pressure sodium (120 V only)
___ HP070- 70 Watt High pressure sodium (120, 208, 240 or 277 V)
___ HP100- 100 Watt High pressure sodium (120, 208, 240 or 277 V)
___ CF028- 28 Watt Compact Fluorescent (120, 208, 240 or 277 V)
___ CF032- 32 Watt Compact Fluorescent (120, 208, 240 or 277 V)
___ CF042- 42 Watt Compact Fluorescent (120, 208, 240 or 277 V)

Ballast Type

___ P Postline

Voltage

___ V1 120 Volt ___ V2 240 Volt
___ V8 208 Volt ___ V7 277 Volt

Socket

___ SD Medium Base ___ SF Fluorescent

Cylinder

___ YCLO Clear Acrylic ___ YCLF Frosted Acrylic

Anchor Bolts:

___ 323/ 3/4" x 24" ___ 130/ 1" x 30"
___ 330/ 3/4" x 30" ___ 136/ 1" x 36"
___ 124/ 1" x 24" ___ 140/ 1" x 40"
___ 1NW- 1Nut & Washer / Bolt
___ 2NW- 2 Nuts & Washers / Bolt

Paint

___ PO Prime Only ___ CB Classic Black
___ BG Bottle Green ___ VG Verde Green
___ GI Grey Iron ___ DB Dark Bronze
___ LB Long Beach Blue ___ UF Unfinished
___ CW Custom Wet ___ XX Modifier
___ CP Custom Powder, advise



SPRING CITY ELECTRICAL MFG. CO., INC.

Hall & Main Streets, P. O. Box 19

Spring City, PA 19475-0019

Phone: 610-948-4000 Fax: 610-948-5577

Website: www.springcity.com

SPRING CITY

Revision 10/2008

Page: BD 22

Kimball Street Bollard

Catalog No.: BDKMB 9-1.75

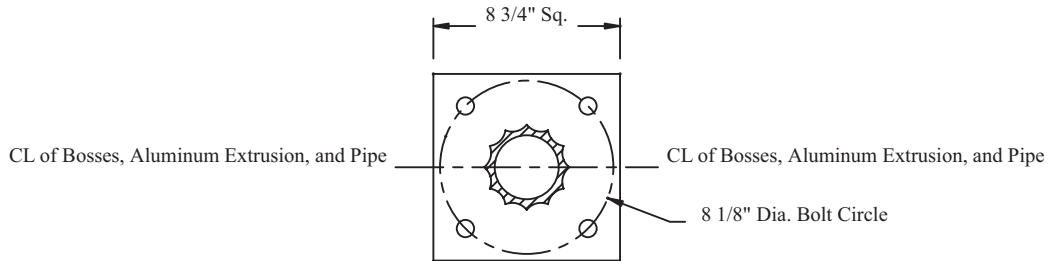
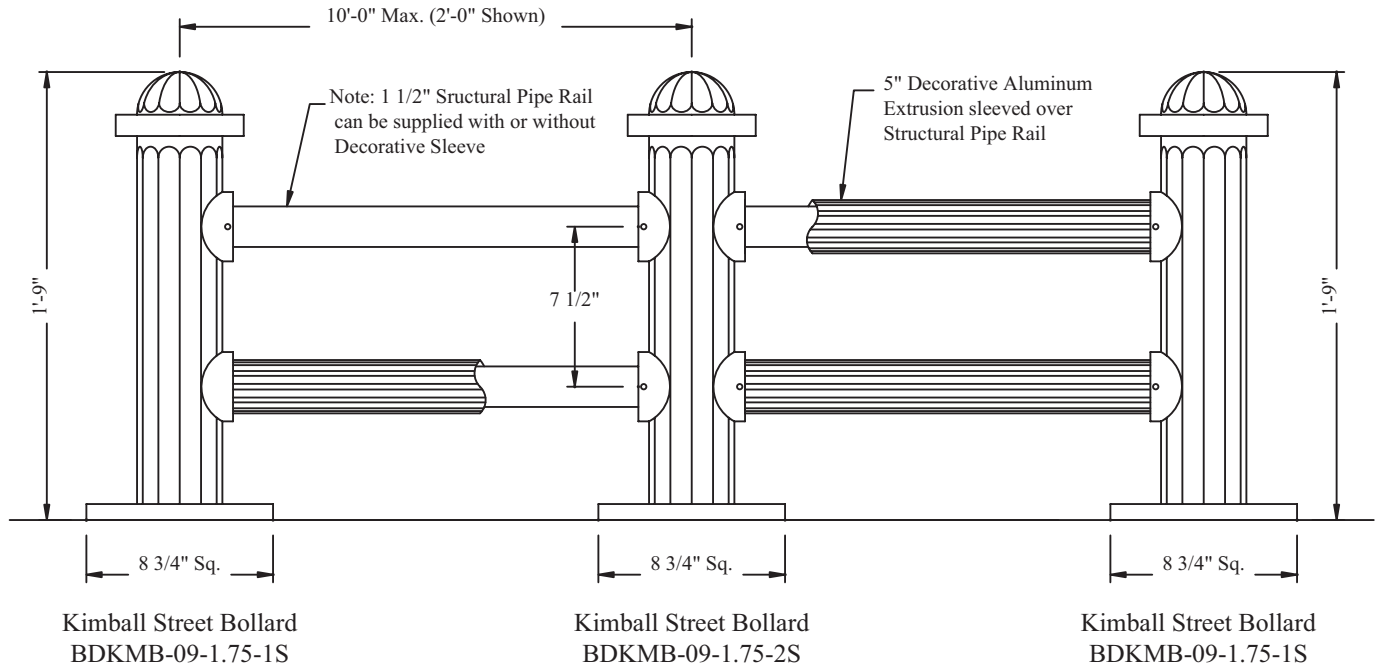

Catalog Number Example: ABDKMB-09-1.75-323/1NW-CB

(Cast Aluminum Bollard Kimball Street-8 3/4" Base Dimension-1' 9" Height-3/4" x 24" Anchor Bolts each with 1 Nut & Washer- Finish Classic Black)

Material Product Style - Base Dimension - Height (see above)-

___ ABDKMB-09-1.75 Cast Aluminum Bollard Kimball St. - 8 3/4" - 1'9"

Modifications

- ___ DD- Direct Burial
- ___ RM- Removable
- ___ EB- Eyebolt
- ___ DP- Dedication Plaque

Anchor Bolts:

- | | |
|----------------------------------|-------------------|
| ___ 323/ 3/4" x 24" | ___ 130/ 1" x 30" |
| ___ 330/ 3/4" x 30" | ___ 136/ 1" x 36" |
| ___ 124/ 1" x 24" | ___ 140/ 1" x 40" |
| ___ 1NW- 1Nut & Washer / Bolt | |
| ___ 2NW- 2 Nuts & Washers / Bolt | |

Paint

- | | |
|------------------------|----------------------|
| ___ PO Prime Only | ___ CB Classic Black |
| ___ BG Bottle Green | ___ VG Verde Green |
| ___ GI Grey Iron | ___ DB Dark Bronze |
| ___ LB Long Beach Blue | ___ UF Unfinished |
| ___ CW Custom Wet | ___ XX Modifier |
| ___ CP Custom Powder | |



SPRING CITY ELECTRICAL MFG. CO., INC.
 Hall & Main Streets, P. O. Box 19
 Spring City, PA 19475-0019
 Phone: 610-948-4000 Fax: 610-948-5577
 Website: www.springcity.com

SPRING CITY

Revision 10/2008

Page: BD 23

Yorktown Bollard

Catalog No.: BDYRK-12-4.19

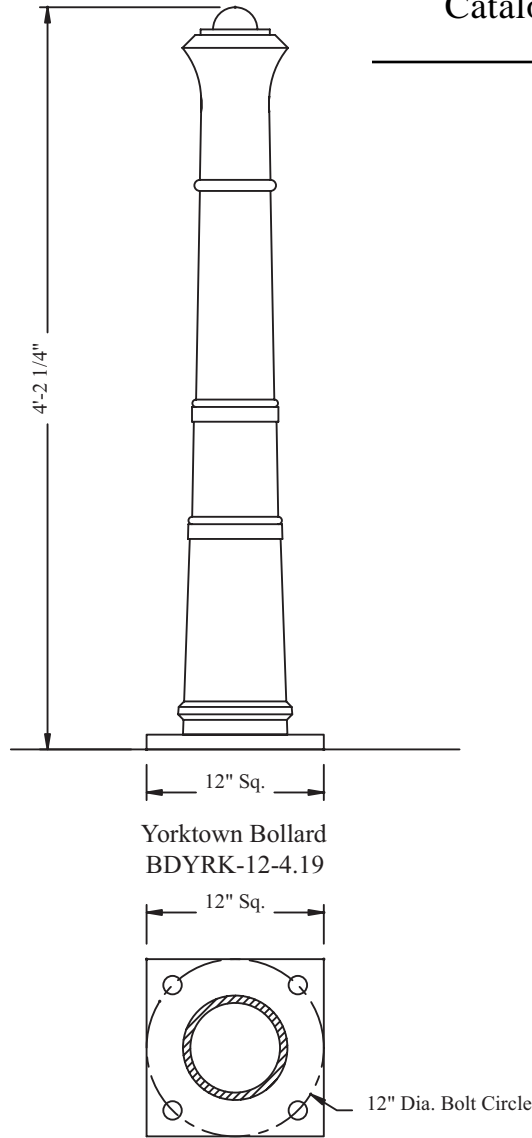

Yorktown Bollard
BDYRK-12-4.19

Catalog Number Example: DBDYRK-12-4.19-323/1NW-CB

(Cast Ductile Iron Bollard Yorktown-12" Base Dimension-4' 2 1/4" Height-3/4" x 24" Anchor Bolts each with 1 Nut & Washer- Finish Classic Black)

Material Product Style - Base Dimension - Height -

- ___ IBDYRK-12-4.19- Cast Iron Bollard Yorktown - 12" - 4' 2 1/4"
- ___ DBDYRK-12-4.19- Cast Ductile Iron Bollard Yorktown - 12" - 4' 2 1/4"
- ___ ABDYRK-12-4.19- Cast Aluminum Bollard Yorktown - 12" - 4' 2 1/4"

Modifications

- ___ DD- Direct Burial
- ___ RM- Removable
- ___ EB- Eyebolt
- ___ DP- Dedication Plaque

Anchor Bolts:

- ___ 323/ 3/4" x 24" ___ 130/ 1" x 30"
- ___ 330/ 3/4" x 30" ___ 136/ 1" x 36"
- ___ 124/ 1" x 24" ___ 140/ 1" x 40"
- ___ 1NW- 1Nut & Washer / Bolt
- ___ 2NW- 2 Nuts & Washers / Bolt

Paint

- ___ PO Prime Only ___ CB Classic Black
- ___ BG Bottle Green ___ VG Verde Green
- ___ GI Grey Iron ___ DB Dark Bronze
- ___ LB Long Beach Blue ___ UF Unfinished
- ___ CW Custom Wet ___ XX Modifier
- ___ CP Custom Powder



SPRING CITY ELECTRICAL MFG. CO., INC.
Hall & Main Streets, P. O. Box 19
Spring City, PA 19475-0019
Phone: 610-948-4000 Fax: 610-948-5577
Website: www.springcity.com

Madrid Bollards

Catalog No.: BDMDR-12-2.75/2.57

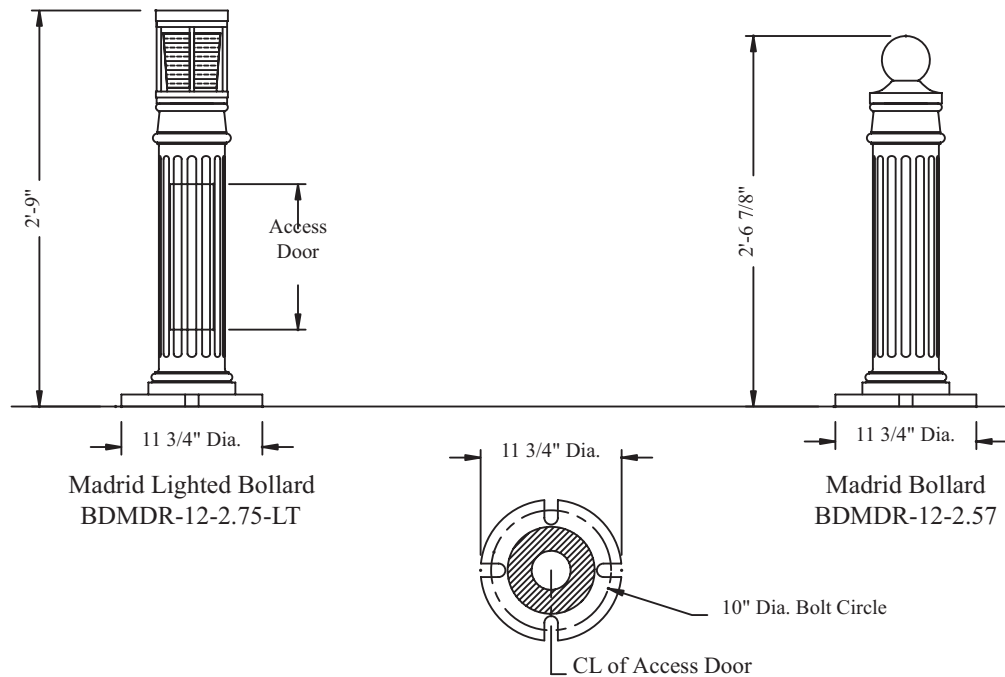

Lighted Bollard Catalog Number Example: IDBMDR-12-2.75-LT-MH050-PV1-SD-L55-323/1NW-BG (Cast Iron Bollard Madrid - 11 3/4" Base Dimensions- 2'9" Height- Lighted- 50 Watt Metal Halid - Postline Ballast 120 Volt- Medium Base Socket-Internal Type V Refractor- 3/4" X 24" Anchor Bolts each with 1 Nut & Washer - Finish Bottle Green)

Material Product Style - Base Dimension - Height (see above)-

___IBDMDR-12-___ (Ht)- Cast Iron Bollard Madrid- 11 3/4"- ___ Ht-
 ___DBDMDR-12-___(Ht)-Cast Ductile Iron Bollard Madrid- 11 3/4"-___ Ht-
 ___ABDMDR-12-___(Ht)- Cast Aluminum Bollard Madrid- 11 3/4"- ___ Ht-

Modifications

___DD- Direct Burial ___LT- Lighted
 ___RM- Removable ___EB- Eyebolt
 ___DP- Dedication Plaque

Lamping

___IN- Incandescent
 ___MH035- 35 Watt Metal Halid (120 or 277 V) F-can Ballast Only
 ___MH050- 50 Watt Metal Halid (120 V Only)
 ___MH070- 70 Watt Metal Halid (120 or 277 V) F-can Ballast Only
 ___MH100- 100 Watt Metal Halid (120 or 277 V) F-can Ballast Only
 ___HP035- 35 Watt High pressure sodium (120 V Only)
 ___HP050- 50 Watt High pressure sodium (120 V Only)
 ___HP070- 70 Watt High pressure sodium (120, 208, 240 or 277 V)
 ___HP100- 100 Watt High pressure sodium (120, 208, 240 or 277 V)
 ___CF028- 28 Watt Compact Fluorescent (120, 208, 240 or 277 V)
 ___CF032- 32 Watt Compact Fluorescent (120, 208, 240 or 277 V)
 ___CF042- 42 Watt Compact Fluorescent (120, 208, 240 or 277 V)

Ballast Type

___ P Postline ___ F F-can (120/277 V Only)

Voltage

___ V1- 120 Volt ___V2- 240 Volt
 ___ V8- 208 Volt ___V7- 277 Volt

Socket

___SD- Medium Base ___SF- Fluorescent

Internal Refractor

___ L55- Internal Type V

Anchor Bolts:

___ 323/ 3/4" x 24" ___ 130/ 1" x 30"
 ___ 330/ 3/4" x 30" ___ 136/ 1" x 36"
 ___ 124/ 1" x 24" ___ 140/ 1" x 40"
 ___ 1NW- 1Nut & Washer / Bolt
 ___ 2NW- 2 Nuts & Washers / Bolt

Paint

___ PO Prime Only ___ CB Classic Black
 ___ BG Bottle Green ___ VG Verde Green
 ___ GI Grey Iron ___ DB Dark Bronz
 ___ LB Long Beach Blue ___ UF Unfinished
 ___ CW Custom Wet ___ XX Modifier
 ___ CP Custom Powder



SPRING CITY ELECTRICAL MFG. CO., INC.

Hall & Main Streets, P. O. Box 19

Spring City, PA 19475-0019

Phone: 610-948-4000 Fax: 610-948-5577

Website: www.springcity.com

SPRING CITY

Revision 10/2008

Page: BD 25